

Biquaternion Generalized Maxwell Equations: Longitudinal and Scalar Waves

Robert M. Haralick

Computer Science, Graduate Center
City University of New York

James Clerk Maxwell	(19 Slides)
The Maxwell Equations In Modern Form	(23 Slides)
Maxwell's Original 20 Equations	(14 Slides)
Quaternions	(13 slides)
Quaternion Generalized Maxwell Equations	(18 slides)
Tesla, Galinas, Zimmerman, Hively	(89 Slides)
Tesla	(33 Slides)
Galinas	(10 Slides)
Zimmerman	(40 Slides)
Hively	(6 Slides)

- James Clerk Maxwell
- The Maxwell Equations In Modern Form
- Maxwell's Original 20 Equations
- Quaternions
- Quaternion Generalized Maxwell Equations
- Tesla, Galinas, Zimmerman, Hively

James Clerk Maxwell



https://upload.wikimedia.org/wikipedia/commons/1/1e/James_Clerk_Maxwell_big.jpg

The only one who can stand between
Newton and Einstein
is
James Clerk Maxwell

When Einstein visited Cambridge. He was asked if he had stood on the shoulders of Newton. He replied

No, I stand on Maxwell's shoulders

Richard Feynman said that

*... the great transformations of ideas come very infrequently
... we might think of Newton's discovery of the laws of mechanics and gravitation, Maxwell's theory of electricity and magnetism, Einstein's theory of relativity, and ... the theory of quantum mechanics.*

Maxwell As A Child With Mother

Born June 13, 1831 Edinburgh Scotland



Maxwell as Student

- At 16 he enrolled at the University of Edinburgh 1847-1850
- Three years later he attended Cambridge University's Trinity College 1850-1856
 - Studied Optics and Color



First Stanza of Poem To His Wife To Be

*Oft in the night, from this lone room
I long to fly o'er land and sea,
To pierce the dark, dividing gloom,
And join myself to thee.*

Maxwell as Professor of Natural Philosophy



faculty.humanities.uci.edu/bjbecker/ExploringtheCosmos/maxwellportb.jpg

- 1858 Joined the Physics Faculty Marischal University
- 1858 Married Katherine Mary Dewar

Saturn's Rings

- Theorized that the rings of Saturn are comprised of particles
- 1857 wrote the essay *The Stability of Saturn's Rings*
- Received the Adam Prize
- Confirmed by 20th century space probes
 - The rings are made out of particles ranging from microscopic dust to barnyard sized boulders
 - With perhaps a few kilometer-sized objects as well

Saturn's Rings



NASA photo

First Color Photography

- Maxwell outlined the strategy of producing full color images
 - 1855 *On the Theory of colors in relation to color-blindness*
 - 1857 Published in the Royal Society of Edinburgh Transactions
- 1860 Awarded Rumford Medal of the Royal Society of London
 - For his research on the composition of colors and other optical properties
- 1861 *On the Theory of Compound Colors*
 - Philosophical Transactions Royal Society of London 1860-1861
- 1861 *On the Theory of Three Primary Colors*
 - Lecture at the Royal Institution of Great Britain

Three Color Separations

- Maxwell worked with Photographer Thomas Sutton
 - Inventor of the single lens reflex camera
 - Inventor of the panoramic camera with wide angle lens



www.edinphoto.org.uk

On Display in Maxwell's Museum

Maxwell's Color Image Projector

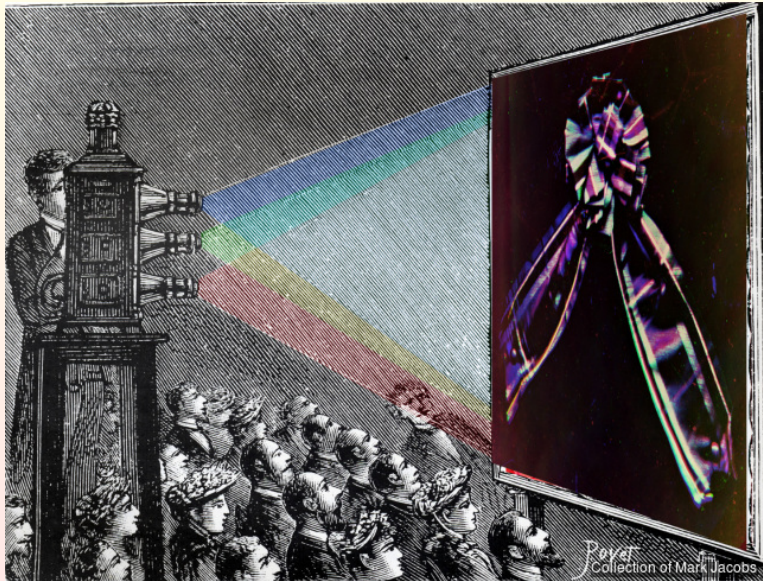

<http://designblog.rietveldacademie.nl/wp-content/uploads/2018/02/display-color-photo.jpg>

First Color Projection

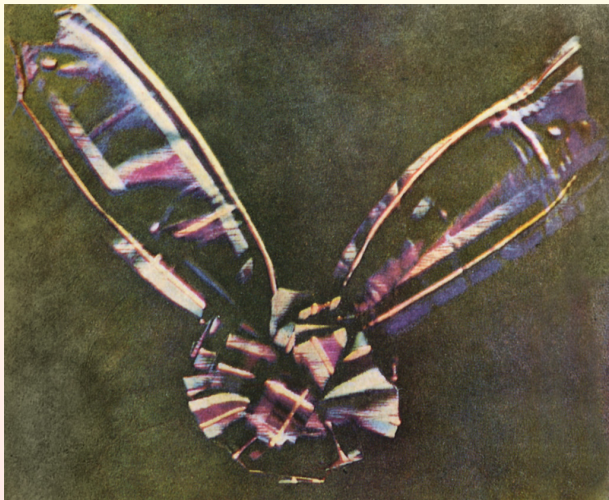

scihi.org/james-clerk-maxwell-color-photograph

Katherine Mary Dewar and James Clerk Maxwell 1869



upload.wikimedia.org/wikipedia/commons/3/33/JamesClerkMaxwell-KatherineMaxwell-1869.jpg

Katherine worked with her husband on Color Vision experiments

- 1860-1865 Kings College
- 1861 Elected Fellow of Royal Society
- *On Physical Lines of Force*
 - Philosophical Magazine Vols 21 and 23 1861/1862
- “We can scarcely avoid the inference that light consists in the transverse undulations of the same medium which is the cause of electric and magnetic phenomena”
- 1865 *A Dynamical Theory of the Electromagnetic Field*
- 1865-1871 Lived in Glenair at the Maxwell estate

Maxwell in Later Years

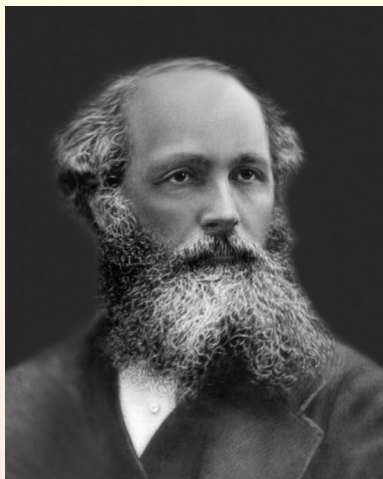

- 1869 *The construction of stereograms of surfaces*
- 1871 Established the Cavendish Laboratory at Cambridge
- 1873 *Treatise on Electricity and Magnetism*

Maxwell Is Sick

As grieving friends and pastors visited him in his sick bed, Maxwell would quote Scripture and Christian poems from memory such as this hymn

Lord, it belongs not to my care,
Whether I die or live;
To love and serve Thee is my share,
And that Thy grace must give.

Maxwell Died of Abdominal Cancer



https://en.wikipedia.org/wiki/James_Clerk_Maxwell

Born June 13, 1831; Died November 5, 1879

He had the same cancer that his mother died of when he was 8 years old.

- James Clerk Maxwell
- The Maxwell Equations In Modern Form
- Maxwell's Original 20 Equations
- Quaternions
- Quaternion Generalized Maxwell Equations
- Tesla, Galinas, Zimmerman, Hively

The Maxwell Equations In Modern Vector Calculus Form

In Cartesian Coordinates

- Del Operator

$$\vec{\nabla} = \begin{pmatrix} \frac{\partial}{\partial x} \\ \frac{\partial}{\partial y} \\ \frac{\partial}{\partial z} \end{pmatrix}$$

- Gradient

$$\vec{\nabla} f(x, y, z, t) = \begin{pmatrix} \frac{\partial f}{\partial x} \\ \frac{\partial f}{\partial y} \\ \frac{\partial f}{\partial z} \end{pmatrix}$$

- Divergence

$$\vec{\nabla} \cdot \vec{A} = \vec{\nabla} \cdot \begin{pmatrix} A_x(x, y, z, t) \\ A_y(x, y, z, t) \\ A_z(x, y, z, t) \end{pmatrix} = \frac{\partial A_x}{\partial x} + \frac{\partial A_y}{\partial y} + \frac{\partial A_z}{\partial z}$$

- Curl

$$\vec{\nabla} \times \vec{A} = \vec{\nabla} \times \begin{pmatrix} A_x \\ A_y \\ A_z \end{pmatrix} = \begin{pmatrix} \frac{\partial A_z}{\partial y} - \frac{\partial A_y}{\partial z} \\ \frac{\partial A_x}{\partial z} - \frac{\partial A_z}{\partial x} \\ \frac{\partial A_y}{\partial x} - \frac{\partial A_x}{\partial y} \end{pmatrix}$$

Notational Conventions

ϕ	Electric Potential	<i>volts</i>
\vec{E}	Electric Field Intensity	<i>volts/meter</i>
\vec{B}	Magnetic Flux Density	<i>webers/meter²</i>
\vec{H}	Magnetic Field Intensity	<i>amperes/meter</i>
\vec{A}	Magnetic Vector Potential	<i>webers/meter</i>
\vec{D}	Displacement Flux Intensity	<i>coulombs/meter²</i>
\vec{J}	Current Density	<i>amperes/meter²</i>

For homogeneous media, these are constants

ρ	Volume Charge Density	<i>coulombs/meter³</i>
μ	Permeability	<i>henry/meter</i>
ϵ	Permittivity	<i>farad/meter</i>
$c = \frac{1}{\sqrt{\mu\epsilon}}$	Light Velocity In Vacuum	<i>meter/second</i>

Maxwell's Equations Written In Modern Notation

$$\vec{\nabla} \times \vec{E} = -\frac{\partial \vec{B}}{\partial t}$$

Faraday's Law of Induction

$$\vec{\nabla} \cdot \vec{E} = \frac{\rho}{\epsilon}$$

Gauss' Law for Electricity

$$\vec{\nabla} \times \vec{B} = \mu \left(\vec{J} + \epsilon \frac{\partial \vec{E}}{\partial t} \right)$$

Ampere's Law

$$\vec{\nabla} \cdot \vec{B} = 0$$

Gauss' Law for Magnetism

Faraday's Law of Induction

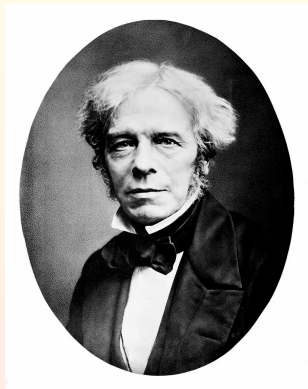

1791-1867

$$\vec{\nabla} \times \vec{E} = -\frac{\partial \vec{B}}{\partial t}$$

A time changing magnetic field induces an electric field that has curl.

The Curl Operator

$$\vec{F} = \begin{pmatrix} y \\ -x \\ 0 \end{pmatrix}$$

$$\vec{\nabla} \times \vec{F} = \begin{pmatrix} 0 \\ 0 \\ -2 \end{pmatrix}$$

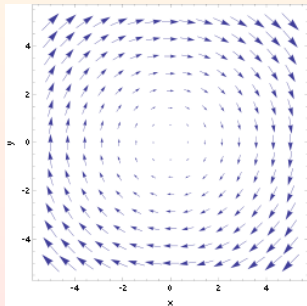

(a) Field Has Uniform Curl

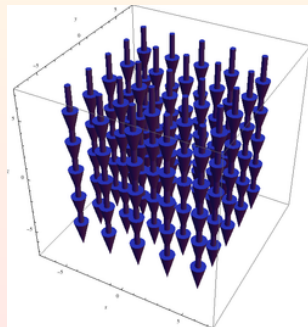

(b) Result Of The Curl Operator

Faraday's Law of Induction

$$\vec{\nabla} \times \vec{E} = -\frac{\partial \vec{B}}{\partial t}$$

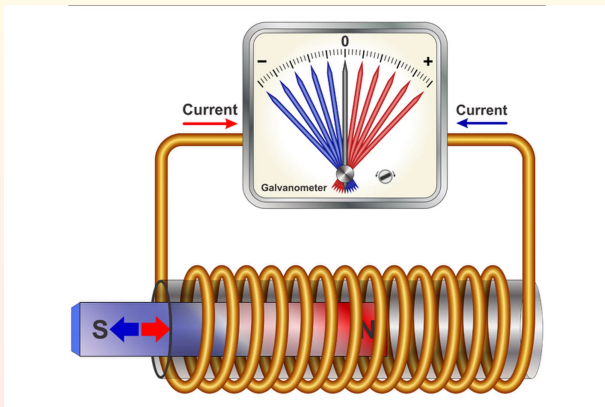

<http://www.livescience.com/images/i/000/081/007/i02/galvanometer.jpg?1453941015>

- A moving magnet creates a time changing magnetic field
- The time changing magnetic field induces a curled electric field

Maxwell's Generalized Ampere's Law



1775-1836

$$\vec{\nabla} \times \vec{B} = \mu \left(\vec{J} + \epsilon \frac{\partial \vec{E}}{\partial t} \right)$$

A current or a changing electric field induces a magnetic field that has curl.

Maxwell's Generalized Ampere's Law

$$\vec{\nabla} \times \vec{B} = \mu \left(\vec{J} + \epsilon \frac{\partial \vec{E}}{\partial t} \right)$$

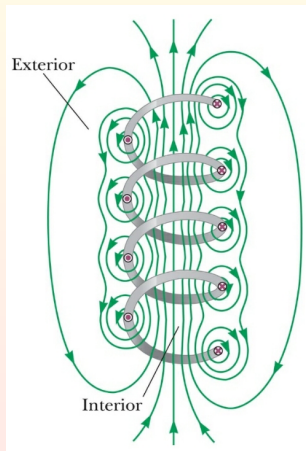

From Michael Ashley University of South Wales Australia Physics 1231 lecture

A current or a changing electric field induces a curled magnetic field

The Transformer

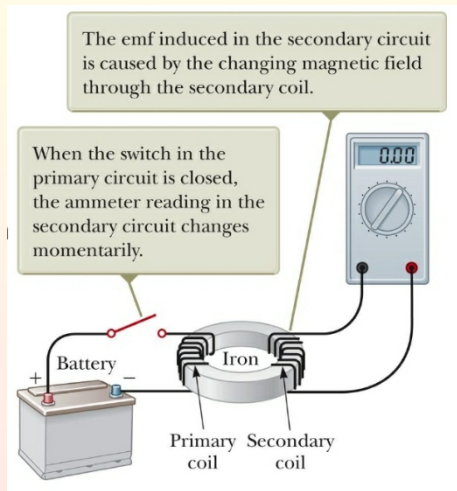

$$\vec{\nabla} \times \vec{B} = \mu \left(\vec{J} + \epsilon \frac{\partial \vec{E}}{\partial t} \right)$$

$$\vec{\nabla} \times \vec{E} = -\frac{\partial \vec{B}}{\partial t}$$

Gauss' Law for Electricity



1777-1855

$$\vec{\nabla} \cdot \vec{E} = \frac{\rho}{\epsilon}$$

The net electric field flux flowing through a closed surface equals the charge inside divided by the permittivity

$$\vec{\nabla} \cdot \vec{E} = \frac{\rho}{\epsilon}$$

Electric Fields of Individual Charged Particles (Point Charges):

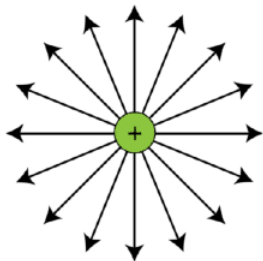

Electric field lines of a positive point charge

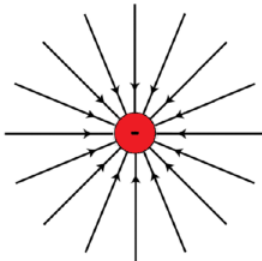

Electric field lines of a negative point charge

https://s3.amazonaws.com/ai2-vision-textbook-dataset/dataset_releases/rc2/val/textbook_images/electric_fields_22787.png

There is an outflowing field for a positive charge and an inflowing field for a negative charge.

Electric Field Flux Divergence

$$\vec{\nabla} \cdot \vec{E} = \frac{\rho}{\epsilon}$$

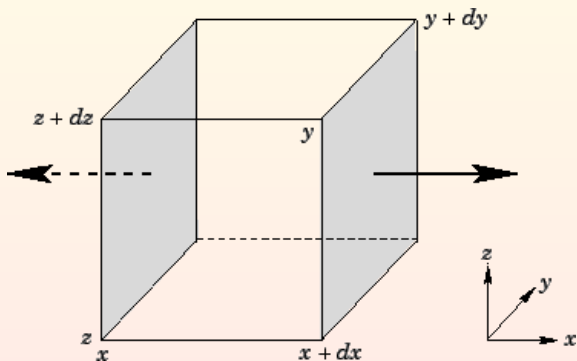

In a differential volume element, the net flux flowing out of the bounding surface of the volume equals the charge inside the volume element divided by the permittivity of what is inside the volume element.

Gauss' Law for Magnetism



1777-1855

The magnetic field flux flowing through a closed surface equals zero.
There are no magnetic monopoles.

$$\vec{\nabla} \cdot \vec{B} = 0$$

Divergence of Magnetic Field Flux is Zero

$$\vec{\nabla} \cdot \vec{B} = 0$$

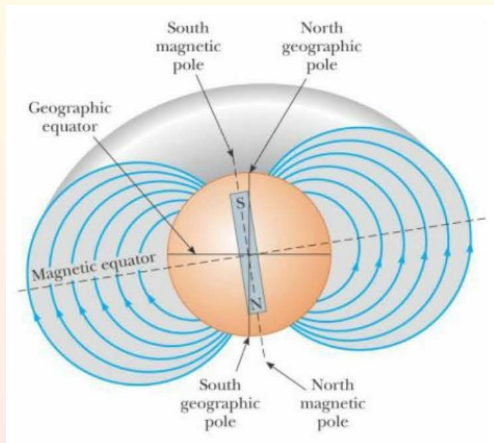

From Michael Ashley University of South Wales Australia Physics 1231 lecture

The total field flux flowing out of the sphere equals the total field flux flowing into the sphere.

Implied By Maxwell's Four Fundamental Equations

$$\vec{\nabla} \cdot \vec{J} = -\frac{\partial \rho}{\partial t}$$

Continuity Equation

$$\nabla^2 \vec{E} - \frac{1}{c^2} \frac{\partial^2 \vec{E}}{\partial t^2} = \vec{0}$$

Wave Equation for \vec{E}

$$\nabla^2 \vec{B} - \frac{1}{c^2} \frac{\partial^2 \vec{B}}{\partial t^2} = -\mu(\vec{\nabla} \times \vec{J})$$

Wave Equation for \vec{B}

Transverse and Longitudinal Waves

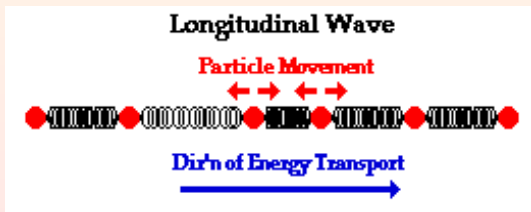
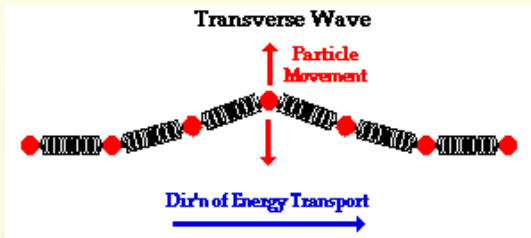

<https://www.physicsclassroom.com/class/waves/Lesson-1/Categories-of-Waves>

The Transverse Wave: No Charges And No Currents

$$\nabla^2 \vec{E} - \frac{1}{c^2} \frac{\partial^2 \vec{E}}{\partial t^2} = \vec{0}$$
$$\vec{\nabla}^2 \begin{pmatrix} E_x \\ E_y \\ E_z \end{pmatrix} - \frac{1}{c^2} \begin{pmatrix} \frac{\partial^2 E_x}{\partial t^2} \\ \frac{\partial^2 E_y}{\partial t^2} \\ \frac{\partial^2 E_z}{\partial t^2} \end{pmatrix} = \begin{pmatrix} 0 \\ 0 \\ 0 \end{pmatrix}$$

- Rotate the x, y, z axes so that $E_x = E_y = 0$
- $\vec{\nabla} \cdot \vec{E} = 0$ implies that $\frac{\partial E_z}{\partial z} = 0$
- So that $E_z = E_z(x, y, t)$
- This means that the wave is transverse and there is no possibility for a longitudinal wave

The Transverse Plane Wave: Periodic Solution

$$\nabla^2 E_z - \frac{1}{c^2} \frac{\partial^2 E_z}{\partial t^2} = 0$$

$$\text{A Periodic Solution } E_z(x, y, t) = \alpha e^{j(kx - \omega t)} + \beta e^{j(kx + \omega t)}$$

where

$$k = \frac{\omega}{c} = \frac{2\pi f}{c} = \frac{2\pi}{Tc} = \frac{2\pi}{\lambda}$$

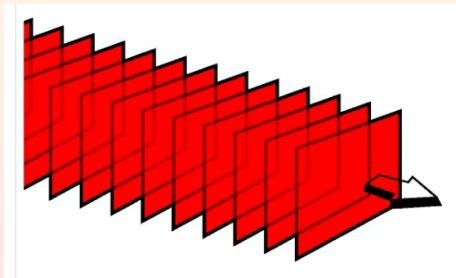

The planes are orthogonal to z , the propagation direction

Maxwell's Poem Valentine By A Telegraph Clerk

The poem uses the names of three kinds of batteries:

- Daniell cell
 - uses copper pot cathode with copper sulfate solution
 - zinc anode in sulfuric acid
 - anode and cathode are separated by porous ceramic
 - provides a more constant current
 -
- Grove cell
 - uses zinc anode in sulfuric acid and platinum cathode in nitric acid
 - anode and cathode are separated by porous ceramic
 - provides a greater voltage and current than Daniell cell
- Smee Battery
 - uses zinc anode and silver cathode
 - electrolyte is sulphuric acid

Valentine By A Telegraph Clerk

*The tendrils of my soul are twined
With thine, though many a mile apart.
And thine in close coiled circuits wind
Around the needle of my heart.*

*Constant as Daniell, strong as Grove.
Ebullient throughout its depths like Smee,
My heart puts forth its tide of love,
And all its circuits close in thee.*

*O tell me, when along the line
From my full heart the message flows,
What currents are induced in thine?
One click from thee will end my woes.*

*Through many a volt the weber flew,
And clicked this answer back to me;
I am thy farad staunch and true,
Charged to a volt with love for thee.*

Maxwell's 20 equations

A Dynamical Theory of the Electromagnetic Field

The equations are from part III – *General Equations of the Electromagnetic Field* of Maxwell's 1865 Paper¹

His paper had no quaternions.

¹James Clerk Maxwell, *A Dynamical Theory of the Electromagnetic Field*, Philosophical Transactions of the Royal society of London, Vol 155, 1865, pp. 459-512.

Notational Conventions

For homogeneous media, these are constants

Volume Charge Density

$$\rho \text{ coulombs/meter}^3$$

Maxwell's usage Resistivity

$$\rho \text{ ohms/meter}$$

Permeability

$$\mu \text{ henry/meter}$$

Permittivity

$$\epsilon \text{ farad/meter}$$

Conductivity per unit length

$$\sigma \text{ ampere/(volt - meter)}$$

Resistivity

$$\rho = -\frac{1}{\sigma} \text{ ohms/meter}$$

Definition of Total Current Density

Conduction Current Density $\begin{pmatrix} p \\ q \\ r \end{pmatrix} = \vec{J} \text{ amperes/meter}^2$

Displacement Current Density $\begin{pmatrix} f \\ g \\ h \end{pmatrix} = \vec{D} \text{ coulombs/meter}$
 $= \epsilon \vec{E}$

Total Current Density $\begin{pmatrix} p' \\ q' \\ r' \end{pmatrix} = \vec{J}_{total} \text{ amperes/meter}^2$

$$\vec{J}_{total} = \vec{J} + \epsilon \frac{\partial \vec{E}}{\partial t}$$

Notational Conventions

Magnetic Field Intensity $\begin{pmatrix} \alpha \\ \beta \\ \gamma \end{pmatrix} = \vec{H}$ amperes/meter

Magnetic Flux Density $\vec{B} = \mu\vec{H}$ webers/meter²

Magnetic Vector Potential $\begin{pmatrix} F \\ G \\ H \end{pmatrix} = \vec{A}$ webers/meter

Electric Field Intensity $\begin{pmatrix} P \\ Q \\ R \end{pmatrix} = \vec{E}$ volts/meter

Volume Charge Density $e = \rho$ coulombs/meter³

Electric Potential $\psi = \phi$ volts

Conductivity $\sigma = mhos/meter$

Equation (A) Total Electric Current

Maxwell wrote

$$\rho' = \rho + \frac{\partial f}{\partial t}$$

$$q' = q + \frac{\partial g}{\partial t}$$

$$r' = r + \frac{\partial h}{\partial t}$$

Modern notation

$$\vec{J}_{total} = \vec{J} + \frac{\partial \vec{D}}{\partial t}$$

Equation (B) Magnetic Force

Maxwell wrote

$$\mu\alpha = \frac{\partial H}{\partial y} - \frac{\partial G}{\partial z}$$

$$\mu\beta = \frac{\partial F}{\partial z} - \frac{\partial H}{\partial x}$$

$$\mu\gamma = \frac{\partial G}{\partial x} - \frac{\partial F}{\partial y}$$

Modern Notation

$$\vec{B} = \mu\vec{H} = \vec{\nabla} \times \vec{A}$$

Equation (C) Ampere's Law

Maxwell wrote

$$\frac{\partial \gamma}{\partial y} - \frac{\partial \beta}{\partial z} = \rho'$$

$$\frac{\partial \alpha}{\partial z} - \frac{\partial \gamma}{\partial x} = q'$$

$$\frac{\partial \beta}{\partial x} - \frac{\partial \alpha}{\partial y} = r'$$

Modern Notation

$$\vec{\nabla} \times \vec{H} = \vec{J}_{total}$$

$$\vec{\nabla} \times \vec{B} = \mu \vec{J}_{total} = \mu \left(\vec{J} + \epsilon \frac{\partial E}{\partial t} \right)$$

Equation (D) Lorentz Force

Maxwell wrote

$$P = \mu \left(\gamma \frac{\partial y}{\partial t} - \beta \frac{\partial z}{\partial t} \right) - \frac{\partial F}{\partial t} - \frac{\partial \psi}{\partial x}$$

$$Q = \mu \left(\alpha \frac{\partial z}{\partial t} - \gamma \frac{\partial x}{\partial t} \right) - \frac{\partial G}{\partial t} - \frac{\partial \psi}{\partial y}$$

$$R = \mu \left(\beta \frac{\partial x}{\partial t} - \alpha \frac{\partial y}{\partial t} \right) - \frac{\partial H}{\partial t} - \frac{\partial \psi}{\partial z}$$

Modern Notation

$$\vec{E} = \mu(\vec{v} \times \vec{H}) - \frac{\partial \vec{A}}{\partial t} - \vec{\nabla} \phi$$

$$\vec{F} = q\vec{E} = q \left(\vec{v} \times \vec{B} - \frac{\partial \vec{A}}{\partial t} - \vec{\nabla} \phi \right)$$

Equation (E) Electric Field and Displacement Field Relation

Maxwell's $k = 1/\epsilon$

Maxwell wrote

$$\begin{pmatrix} P \\ Q \\ R \end{pmatrix} = k \begin{pmatrix} f \\ g \\ h \end{pmatrix}$$

Modern Notation

$$\vec{E} = \vec{D}/\epsilon$$

Equation (F) Ohms Law

Maxwell's ρ is the negative of the modern R

$$\begin{pmatrix} P \\ Q \\ R \end{pmatrix} = -\rho \begin{pmatrix} p \\ q \\ r \end{pmatrix}$$

Modern Notation

$$\vec{E} = \vec{J}R$$

Equation (G) Gauss' Law for Electricity

Maxwell wrote

$$e + \frac{\partial f}{\partial x} + \frac{\partial g}{\partial y} + \frac{\partial h}{\partial z} = 0$$

Modern Notation

$$\vec{\nabla} \cdot \vec{D} = \rho$$
$$\vec{\nabla} \cdot \vec{E} = \frac{\rho}{\epsilon}$$

Equation (H) Continuity Equation

Maxwell wrote

$$\frac{\partial e}{\partial t} + \frac{\partial \rho}{\partial x} + \frac{\partial \rho}{\partial y} + \frac{\partial \rho}{\partial z} = 0$$

Modern Notation

$$\vec{\nabla} \cdot \vec{J} = -\frac{\partial \rho}{\partial t}$$

The Divergence of \vec{J} is positive if more current leaves the volume than enters.

The right hand side is the amount of charge per unit time that is decreasing within the volume.

Quaternions

Quaternion Uses

- Inertial Navigation Attitude
- Graphics
- Robotics
- Photogrammetry
- Computer Vision
- Animation
- Special and General Relativity
- Newtonian Mechanics
- Scattering Experiments in Crystallography
- Quantum Mechanics

Quaternion Basis Elements

A quaternion is a linear combination of hypercomplex basis elements
 $1, i, j,$ and k

- $i^2 = -1$
- $j^2 = -1$
- $k^2 = -1$
- $ij = -ji = k$
- $jk = -kj = i$
- $ki = -ik = j$

$a1 + bi + cj + dk$ is a quaternion

Quaternion Multiplication Table

	1	i	j	k
1	1	i	j	k
i	i	-1	k	-j
j	j	-k	-1	i
k	k	j	-i	-1

Some Quaternion Properties

$$\mathbf{X} = x_0\mathbf{1} + x_1i + x_2j + x_3k$$

$$\mathbf{Y} = y_0\mathbf{1} + y_1i + y_2j + y_3k$$

$$\mathbf{Z} = z_0\mathbf{1} + z_1i + z_2j + z_3k$$

$$(\mathbf{X} + \mathbf{Y}) + \mathbf{Z} = \mathbf{X} + (\mathbf{Y} + \mathbf{Z}) \quad \text{Addition is Associative}$$

$$\mathbf{X} + \mathbf{Y} = \mathbf{Y} + \mathbf{X} \quad \text{Addition is Commutative}$$

$$\mathbf{X}(\mathbf{YZ}) = (\mathbf{XY})\mathbf{Z} \quad \text{Multiplication is Associative}$$

$$\mathbf{XY} \neq \mathbf{YX} \quad \text{Multiplication is not Commutative}$$

$$(\mathbf{X} + \mathbf{Y})\mathbf{Z} = \mathbf{XZ} + \mathbf{YZ} \quad \text{Multiplication is Distributive Over Addition}$$

$$\mathbf{Z}(\mathbf{X} + \mathbf{Y}) = \mathbf{ZX} + \mathbf{ZY} \quad \text{Multiplication is Distributive Over Addition}$$

The quaternions form a four-dimensional associative normed division algebra over the real numbers.

Quaternion Representations

$$\mathbf{X} = x_0 \mathbf{1} + x_1 i + x_2 j + x_3 k$$

$$\vec{x} = (x_1, x_2, x_3)$$

$$\mathbf{X} = (x_0, \vec{x})$$

$$\mathbf{Y} = (y_0, \vec{y})$$

$$\begin{aligned}\mathbf{XY} &= (x_0, \vec{x})(y_0, \vec{y}) \\ &= (x_0 y_0 - \vec{x} \cdot \vec{y}, x_0 \vec{y} + \vec{x} y_0 + \vec{x} \times \vec{y})\end{aligned}$$

With the scalar term set to zero, quaternion products can give the dot product, the cross product, the divergence, and the curl.

$$(0, \vec{x})(0, \vec{y}) = (-\vec{x} \cdot \vec{y}, \vec{x} \times \vec{y})$$

$$(0, \vec{\nabla})(0, \vec{y}) = (-\vec{\nabla} \cdot \vec{y}, \vec{\nabla} \times \vec{y})$$

What Maxwell Writes About Quaternions

“In this treatise we have endeavoured to avoid any process demanding from the reader a knowledge of the Calculus of Quaternions. At the same time we have not scrupled to introduce the idea of a vector when it was necessary to do so. When we had occasion to denote a vector by a symbol, we have used a German letter, the number of different vectors being so great that Hamilton’s favourite symbols would have been exhausted at once. Whenever therefore, a German letter is used it denotes a Hamiltonian vector and indicates not only its magnitude, but its direction.”²

²*A Treatise on Electricity and Magnetism*, first edition, 1873, vol.2, p.237. 

Maxwell's Quaternion Notation

A	B	C	D	E	F	G	H	I	J	K	L	M
\mathfrak{A}	\mathfrak{B}	\mathfrak{C}	\mathfrak{D}	\mathfrak{E}	\mathfrak{F}	\mathfrak{G}	\mathfrak{H}	\mathfrak{I}	\mathfrak{J}	\mathfrak{K}	\mathfrak{L}	\mathfrak{M}
N	O	P	Q	R	S	T	U	V	W	X	Y	Z
\mathfrak{N}	\mathfrak{O}	\mathfrak{P}	\mathfrak{Q}	\mathfrak{R}	\mathfrak{S}	\mathfrak{T}	\mathfrak{U}	\mathfrak{V}	\mathfrak{W}	\mathfrak{X}	\mathfrak{Y}	\mathfrak{Z}

Electric Field Intensity	\mathfrak{E}	PQR
Mechanical Force	\mathfrak{F}	XYZ
Magnetic Vector Potential	\mathfrak{A}	$F GH$
Velocity	\mathfrak{G}	$\dot{x}\dot{y}\dot{z}$
Magnetic Force	\mathfrak{H}	$\alpha\beta\gamma$
Magnetic Field	\mathfrak{J}	ABC
Current	\mathfrak{R}	pqr

Equation (A) Total Electric Current

Maxwell wrote

$$\begin{aligned}p' &= p + \frac{\partial f}{\partial t} \\q' &= q + \frac{\partial g}{\partial t} \\r' &= r + \frac{\partial h}{\partial t}\end{aligned}$$

Modern notation

$$\vec{J}_{total} = \vec{J} + \frac{\partial \vec{D}}{\partial t}$$

Maxwell Quaternion notation

$$\mathcal{C} = \mathcal{R} + \frac{\partial}{\partial t} \mathcal{D}$$

[H]

Maxwell's Quaternion Notation

How would Maxwell write: $\vec{B} = \vec{\nabla} \times \vec{A}$?

Recall: $(0, \vec{\nabla})(0, \vec{y}) = (-\vec{\nabla} \cdot \vec{y}, \vec{\nabla} \times \vec{y})$

$$\nabla = (0, \vec{\nabla})$$

$$\mathfrak{A} = (0, \vec{A})$$

$$\mathfrak{B} = (0, \vec{B})$$

$$\nabla \mathfrak{A} = (-\vec{\nabla} \cdot \vec{A}, \vec{\nabla} \times \vec{A})$$

$$\mathfrak{B} = V \nabla \mathfrak{A} = (0, \vec{\nabla} \times \vec{A})$$

V is an operator that sets the scalar part of the quaternion to 0 and leaves the vector part alone

Maxwell's Quaternion Notation

How would Maxwell write: $\vec{\nabla} \cdot \vec{E} = \frac{\rho}{\epsilon}$?

Recall: $(0, \vec{\nabla})(0, \vec{y}) = (-\vec{\nabla} \cdot \vec{y}, \vec{\nabla} \times \vec{y})$

$$\mathcal{E} = (0, \vec{E})$$

$$\nabla = (0, \vec{\nabla})$$

$$\nabla \mathcal{E} = (0, \vec{\nabla})(0, \vec{E}) = (-\vec{\nabla} \cdot \vec{E}, \vec{\nabla} \times \vec{E})$$

$$S(-\vec{\nabla} \cdot \vec{E}, \vec{\nabla} \times \vec{E}) = (-\vec{\nabla} \cdot \vec{E}, \vec{0})$$

$$S \nabla \mathcal{E} = \left(-\frac{\rho}{\epsilon}, \vec{0}\right)$$

$$-S \nabla \mathcal{E} = \left(\frac{\rho}{\epsilon}, \vec{0}\right) = \frac{\rho}{\epsilon}$$

S is an operator that sets the vector part of the quaternion to 0 and leaves the scalar part alone

Maxwell's Quaternions

- Maxwell summarized his equations in a Quaternion form
- He used a scalar operator S to extract the scalar term
- He used a vector operator V to extract the vector term
- His notation was awkward and difficult to understand
- He did no derivations of his equations in Quaternions
- There are no terms that Maxwell had in his equations that are not in the modern Maxwell equations
- It is not true that “Maxwell’s actual theory was written in quaternions” as Tom Bearden writes
- Only after seeing how Maxwell used Quaternions can one come to appreciate the modern vector calculus notation due to Heaviside and Biggs

- James Clerk Maxwell
- The Maxwell Equations In Modern Form
- Maxwell's Original 20 Equations
- Quaternions
- Quaternion Generalized Maxwell Equations
- Tesla, Galinas, Zimmerman, Hively

Quaternion Generalized Maxwell Equations

Notation

- i : imaginary square root of -1
- ϕ : the scalar electric potential
- A : the magnetic vector potential
- c : the velocity of light in vacuum

The quaternion electromagnetic potential \mathbf{A} is defined by

$$\mathbf{A} = \left(\overbrace{\begin{matrix} y_0 \\ \frac{i}{c}\phi \end{matrix}}^{\vec{y}}, \overbrace{\vec{A}}^{\vec{y}} \right)$$

Let the quaternion ∇ be

$$\nabla = \left(\overbrace{\begin{matrix} x_0 \\ \frac{i}{c}\frac{\partial}{\partial t} \end{matrix}}^{\vec{x}}, \overbrace{\vec{\nabla}}^{\vec{x}} \right)$$

Quaternion Generalization

$$\nabla \mathbf{A} = \left(\overbrace{\frac{\iota}{c} \frac{\partial}{\partial t}}^{x_0}, \overbrace{\vec{\nabla}}^{\vec{x}} \right) \left(\overbrace{\frac{\iota}{c} \phi}^{y_0}, \overbrace{\vec{A}}^{\vec{y}} \right)$$

$$\mathbf{XY} = (x_0 y_0 - \vec{x} \cdot \vec{y}, x_0 \vec{y} + \vec{x} y_0 + \vec{x} \times \vec{y})$$

$$\nabla \mathbf{A} = \left(\overbrace{-\frac{1}{c^2} \frac{\partial \phi}{\partial t} - \vec{\nabla} \cdot \vec{A}}^{-S}, \overbrace{\frac{\iota}{c} \left[\frac{\partial \vec{A}}{\partial t} + \vec{\nabla} \phi \right]}^{-\vec{E}} + \overbrace{\vec{\nabla} \times \vec{A}}^{\vec{B}} \right)$$

Scalar, Electric, and Magnetic Field Definitions

$$S = \left(\frac{1}{c^2} \frac{\partial \phi}{\partial t} + \vec{\nabla} \cdot \vec{A} \right)$$

Scalar Field *webers/meter²*

$$\vec{E} = - \left(\frac{\partial \vec{A}}{\partial t} + \vec{\nabla} \phi \right)$$

Electric Field *volts/meter*

$$\vec{B} = \vec{\nabla} \times \vec{A}$$

Magnetic Flux Field *webers/meter²*

The Scalar field and the magnetic Flux field have the same units

Generalized Maxwell Equations From Quaternion Form

$$\begin{aligned} -\nabla^*(\nabla\mathbf{A}) &= -\nabla^*\left(-S, \vec{B} - \frac{\iota}{c}\vec{E}\right) \\ &= \left(\overbrace{-\frac{\iota}{c}\frac{\partial}{\partial t}}^{x_0}, \overbrace{\vec{\nabla}}^{\vec{x}} \right) \left(\overbrace{-S}^{y_0}, \overbrace{\vec{B} - \frac{\iota}{c}\vec{E}}^{\vec{y}} \right) \\ &= \left(-\vec{\nabla} \cdot \vec{B} + \frac{\iota}{c} \left(\frac{\partial S}{\partial t} + \vec{\nabla} \cdot \vec{E} \right), -\frac{1}{c^2} \frac{\partial \vec{E}}{\partial t} - \vec{\nabla} S + \vec{\nabla} \times \vec{B} + -\frac{\iota}{c} \left(\frac{\partial \vec{B}}{\partial t} + \vec{\nabla} \times \vec{E} \right) \right) \\ &= \mu(\iota c \rho, \vec{J}) \end{aligned}$$

Maxwell's Equations With The Scalar Field

$$\vec{\nabla} \cdot \vec{B} = 0$$

$$\frac{\partial S}{\partial t} + \vec{\nabla} \cdot \vec{E} = \frac{\rho}{\epsilon}$$

$$\vec{\nabla} \times \vec{B} - \frac{1}{c^2} \frac{\partial \vec{E}}{\partial t} - \vec{\nabla} S = \mu \vec{J}$$

$$\vec{\nabla} \times \vec{E} + \frac{\partial \vec{B}}{\partial t} = \vec{0}$$

Maxwell's Equations With The Scalar Field

$$\vec{\nabla} \cdot \vec{B} = 0$$

$$\frac{\partial S}{\partial t} + \vec{\nabla} \cdot \vec{E} = 0$$

$$\vec{\nabla} \times \vec{B} - \frac{1}{c^2} \frac{\partial \vec{E}}{\partial t} - \vec{\nabla} S = 0$$

$$\vec{\nabla} \times \vec{E} + \frac{\partial \vec{B}}{\partial t} = \vec{0}$$

Wave Equation: Charge and Current Free Region

It then follows from the Generalized Maxwell Equations that

$$\nabla^2 S - \frac{1}{c^2} \frac{\partial^2 S}{\partial t^2} = 0$$

$$\nabla^2 B - \frac{1}{c^2} \frac{\partial^2 B}{\partial t^2} = \vec{0}$$

$$\nabla^2 E - \frac{1}{c^2} \frac{\partial^2 E}{\partial t^2} = \vec{0}$$

Longitudinal Waves Are Possible

$$\frac{\partial \mathcal{S}}{\partial t} + \vec{\nabla} \cdot \vec{E} = \frac{\rho}{\epsilon}$$

In a region without charges,

$$\frac{\partial \mathcal{S}}{\partial t} + \vec{\nabla} \cdot \vec{E} = 0$$

$$\vec{\nabla} \cdot \vec{E} = -\frac{\partial \mathcal{S}}{\partial t}$$

Choosing a coordinate system so that $E_x = E_y = 0$, we have

$$\frac{\partial E_z}{\partial z} = -\frac{\partial \mathcal{S}}{\partial t}$$

Longitudinal Wave Solution:1

$$\vec{\nabla} \cdot \vec{B} = 0$$

$$\frac{\partial S}{\partial t} + \vec{\nabla} \cdot \vec{E} = 0$$

$$\vec{\nabla} \times \vec{B} - \frac{1}{c^2} \frac{\partial \vec{E}}{\partial t} - \vec{\nabla} S = \vec{0}$$

$$\vec{\nabla} \times \vec{E} + \frac{\partial \vec{B}}{\partial t} = \vec{0}$$

- If $E_x = E_y = 0$ and $E_z = E_z(z, t)$, then $\vec{\nabla} \times \vec{E} = \vec{0}$
- If $\vec{\nabla} \times \vec{E} = \vec{0}$, then $\frac{\partial \vec{B}}{\partial t} = 0$
- If $\frac{\partial \vec{B}}{\partial t} = 0$, then $\vec{B} = \vec{B}(x, y, z)$
- $\vec{\nabla} \times \vec{E} = 0$ is a characteristic of a longitudinal wave field

Longitudinal Wave Solution: 2

$$\frac{\partial S}{\partial t} + \vec{\nabla} \cdot \vec{E} = 0$$
$$\vec{\nabla} \times \vec{B} - \frac{1}{c^2} \frac{\partial \vec{E}}{\partial t} - \vec{\nabla} S = \vec{0}$$

- If $-\frac{1}{c^2} \frac{\partial \vec{E}}{\partial t} - \vec{\nabla} S = \vec{0}$, then $\vec{\nabla} \times \vec{B} = \vec{0}$

Now there results,

$$\frac{\partial S}{\partial t} + \vec{\nabla} \cdot \vec{E} = 0$$
$$-\frac{1}{c^2} \frac{\partial \vec{E}}{\partial t} - \vec{\nabla} S = \vec{0}$$

If there exists \vec{E} and scalar S that satisfy the above equations, then we have found a longitudinal wave solution.

Longitudinal Wave Solution: 3

$$\frac{\partial S}{\partial t} + \vec{\nabla} \cdot \vec{E} = 0$$
$$-\frac{1}{c^2} \frac{\partial \vec{E}}{\partial t} - \vec{\nabla} S = \vec{0}$$

Since $E_x = E_y = 0$ and $E_z = E_z(z, t)$, then $S = S(z, t)$ we have the constraint equations

$$\frac{\partial S}{\partial t} + \frac{\partial E_z}{\partial z} = 0$$
$$\frac{1}{c^2} \frac{\partial E_z}{\partial t} + \frac{\partial S}{\partial z} = 0$$

Longitudinal Wave Solution: 4

Can the wave equations and the constraint equations be simultaneously satisfied?

$$\begin{aligned}\nabla^2 S - \frac{1}{c^2} \frac{\partial^2 S}{\partial t^2} &= 0 \\ \nabla^2 E_z - \frac{1}{c^2} \frac{\partial^2 E_z}{\partial t^2} &= 0 \\ \frac{\partial S}{\partial t} + \frac{\partial E_z}{\partial z} &= 0 \\ \frac{1}{c^2} \frac{\partial E_z}{\partial t} + \frac{\partial S}{\partial z} &= 0\end{aligned}$$

The general solution to the wave equation for E_z is

$$E_z(z, t) = f(z - ct) + g(z + ct)$$

Longitudinal Wave Solution: 5

$$\frac{\partial S}{\partial t} + \frac{\partial[f(z - ct) + g(z + ct)]}{\partial z} = 0$$
$$\frac{1}{c^2} \frac{\partial[f(z - ct) + g(z - ct)]}{\partial t} + \frac{\partial S}{\partial z} = 0$$

Then,

$$\frac{\partial S}{\partial t} = -f'(z - ct) - g'(z + ct)$$
$$\frac{\partial S}{\partial z} = \frac{1}{c}[f'(z - ct) - g'(z + ct)]$$

The solution is

$$S(z, t) = \frac{1}{c}[f(z - ct) - g(z + ct)]$$

And this satisfies the wave equation for S

Units of Scalar Field S

- E_z has units of *volts/meter* = $MLT^{-2}Q^{-1}$
- S has units of

$$\frac{\text{volts/meter}}{\text{meters/second}} = \frac{MLT^{-2}Q^{-1}}{LT^{-1}} = MT^{-1}Q^{-1} = \text{webers/meter}^2$$

- *weber/meter*² are the units of the magnetic flux density \vec{B}
- The scalar field S is a scalar field of magnetic flux density!
- But without the field direction

What Happened to the B field?

$$\vec{B} = \vec{B}(x, y, z)$$

$$\vec{\nabla} \cdot \vec{B} = 0$$

$$\vec{\nabla} \times \vec{B} = \vec{0}$$

$\vec{B} = \vec{0}$ is a solution

$$\vec{B}(x, y, z, t) = \vec{B}(x, y, z)$$

- James Clerk Maxwell
- The Maxwell Equations In Modern Form
- Maxwell's Original 20 Equations
- Quaternions
- Quaternion Generalized Maxwell Equations
- Tesla, Galinas, Zimmerman, Hively

Nikola Tesla: Radiant Energy

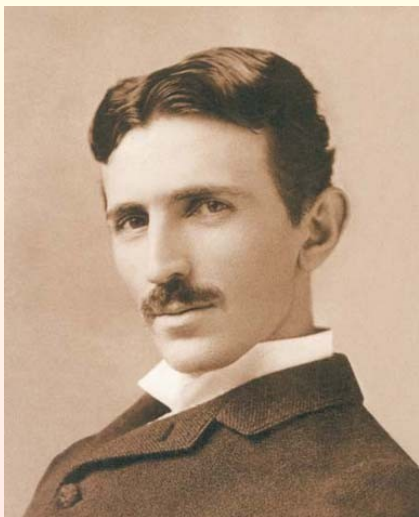

https://upload.wikimedia.org/wikipedia/commons/7/77/Tesla_Sarony.jpg

I don't care that they stole my idea.. I care that they don't have any of their own

Tesla Mosaic

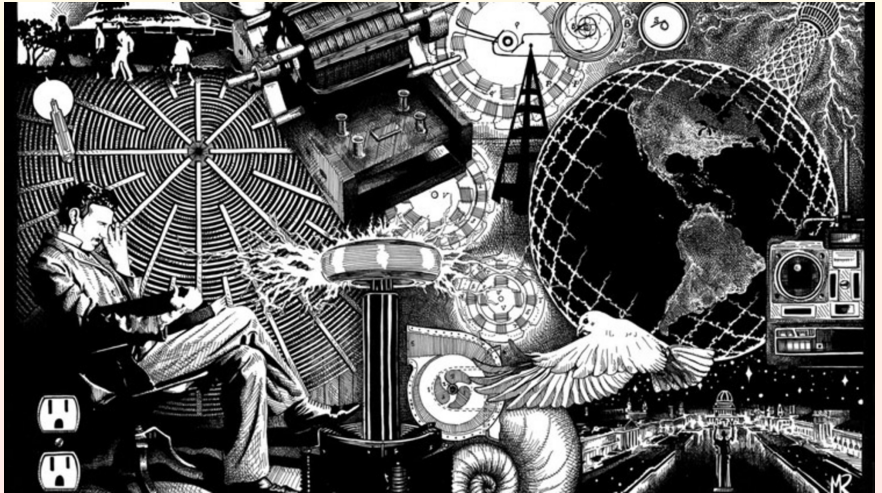

<https://www.higherperspectives.com/nikola-tesla-quotes-1406167140.html>

Power Distribution Using Repetitive Disruptive Pulses

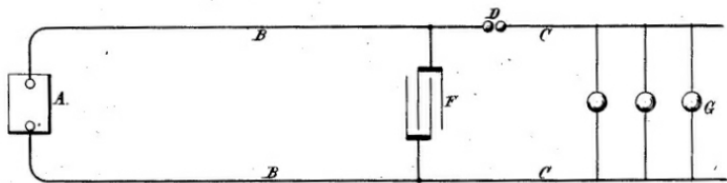

Patent US 462418, November 3, 1891

- Repetitive Pulses
- High Repetition Rate
- Small Duty Cycle
- No Mechanical Disrupter Device

A	DC Generator
B,C	Conductors
F	Capacitor
D	Spark Gap
G	Lamps or Motors

Large Current Rush

- There was a super large rush current with the switch turn-on of a high voltage DC source
- Tesla calculated that the electrostatic concentration was several orders in magnitude greater than any voltage that the DC source could supply
- The supply voltage was being amplified or transformed

Gerry Vassilatos, *Secrets of Cold War Technology*, Borderland Sciences, Bayside California, 1996.

Peter Lindemann, *The Free Energy Secrets of Cold Electricity*, Clear Tech, Inc., Metaline Falls WA, 2000.

Abrupt Disruptive Discharges

An Abrupt discharge

- Is capable of exploding wires into vapor
- Propelled very sharp shockwaves
- Shockwaves struck Tesla with great force
- Shockwaves were not shielded by a Faraday cage
 - This implies the waves generated were Longitudinal Electric Waves
- There was a super large rush current with the turn-on of a high voltage DC dyanmo
- Only a one wire connection was needed

Gerry Vassilatos, *Secrets of Cold War Technology*, Borderland Sciences, Bayside California, 1996.

Peter Lindemann, *The Free Energy Secrets of Cold Electricity*, Clear Tech, Inc., Metaline Falls WA, 2000.

Nikola Tesla, 'Experiments with Alternate Currents of High Potential and High Frequency', *Journal of the Institution of Electrical Engineers*, Vol. XXI No. 97, 1892.

Bunching or Barrier Effect

- Tesla understood that the resistance of lines or components viewed from the DC dynamo end seemed to be an impossible barrier for charge carriers to penetrate
- Electrostatic charges were literally stopped and held for an instant by the barrier which only existed during the brief millisecond interval in which the power switch was closed.
- The sudden force application against this barrier squeezed charge into a density impossible to obtain with ordinary capacitors.

Gerry Vassilatos, *Secrets of Cold War Technology*, Borderland Sciences, Bayside California, 1996.
Peter Lindemann, *The Free Energy Secrets of Cold Electricity*, Clear Tech, Inc., Metaline Falls WA, 2000.

What Tesla Discovered

- Initial cause is the abruptness of the charging
- The instance of switch closure and its break, thrust the white light out into space
- Effect suggested that it was related to a unipolar impulse
- Effect could be destroyed by a reversal of the current
- Effect was amplified by placing a capacitor between the gap and the high voltage DC source
- A magnetic field placed across the spark gap quenched the spark, blew out the spark
- The shock wave forced charges in the direction of their propagation

Gerry Vassilatos, *Secrets of Cold War Technology*, Borderland Sciences, Bayside California, 1996.

Peter Lindemann, *The Free Energy Secrets of Cold Electricity*, Clear Tech, Inc., Metaline Falls WA, 2000.

Pulse Length

- Repetitive pulses each exceeding ≈ 100 [92] microseconds duration produced pain and mechanical pressures
- The mechanical pressure was able to make objects visibly vibrate
- Pain and physical movements ceased when impulses of ≈ 100 [92] microseconds or less were produced
- Pulse duration of 1 microsecond duration produced a strong physiological sense of heat
- Pulse duration of less than 1 microsecond produced a physiological sense of coolness and breezes

Gerry Vassilatou, *Secrets of Cold War Technology*, Borderland Sciences, Bayside California, 1996.
Peter Lindemann, *The Free Energy Secrets of Cold Electricity*, Clear Tech, Inc., Metaline Falls WA, 2000.

Tesla's Conclusions

- There is a Radiant Pulse
- Typically the Radiant Pulse is produced by abrupt unipolar pulses
- Radiant Pulse moved over the coil and not through its wires
- The electrons could not travel as quickly as the Radiant Pulse
- The Radiant Pulse was not *electrical or magnetic* in nature!
- The Radiant effects increased in intensity over time

Gerry Vassilatos, *Secrets of Cold War Technology*, Borderland Sciences, Bayside California, 1996.
Peter Lindemann, *The Free Energy Secrets of Cold Electricity*, Clear Tech, Inc., Metaline Falls WA, 2000.

Replications and Related Experiments

Different aspects of Tesla's abrupt unipolar Radiant Energy were replicated by many people among whom are

1934	Thomas Henry Moray	1990's	John Bedini
1973	Edwin Gray	2000	Ernst Willem van der Bergh
1980's	Paul Baumann	2008	Karl Palsness
1980's	Loren Zanier	2010	Roberto Handwerker
1988	Eric Dollard		

Tesla Bifilar Pancake Coil 1894

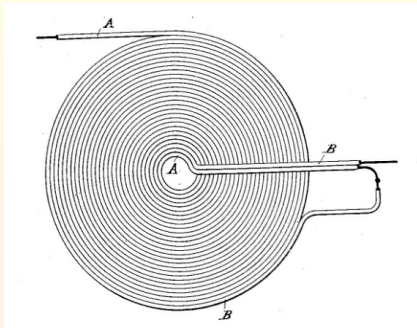

Tesla US Patent 512340 January 9, 1894

- Wound in same direction
- Maximum inductance for single layer
- Preserves impulse integrity
- The voltage difference between adjacent turns is small in ordinary pancake coils
- Bifilar pancake coil: the voltage difference between adjacent turns is larger
- This increases the energy stored in the capacitive coupling between adjacent turns: $E = \frac{1}{2} CV^2$

Transmitting and Receiving of Electrical Energy

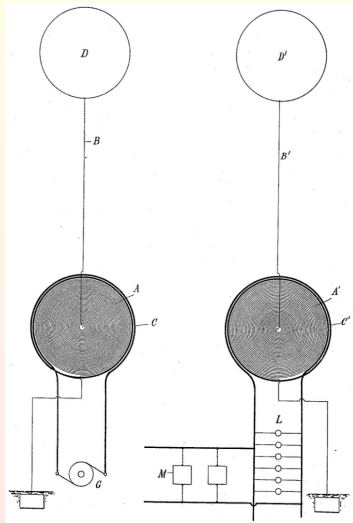

Tesla US Patent 649621, May 15, 1900

Tesla used a pancake coil to feed the spherical antenna

- A,A' Secondary Pancake Coil
Secondary is Grounded
- B,B' Conductor
- C,C' Primary
- D Transmitting Spherical Antenna
- D' Receiving Spherical Antenna
Antenna's act as capacitors in a tuned circuit configuration
- G Current Source; Has Capacitive Reactance; Part of tuned circuit
- L Lamps Load
- M Motors Load
- Ground The ground is capacitively coupled and forms a resonating tank circuit; Ground
Longitudinal transmission

Tesla's Earth Ground Is Not A Simple Ground Rod

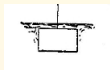

Tesla Ground Symbol



Circuit Ground Symbol



Chassis Ground Symbol

- The ground has to *grip* the earth
- The earth is conductive has inductance and capacitance
- The secondary ground is capacitively coupled to the earth
- The ground and the earth constitute a resonant tank system
- The ground system transforms potential latent energy to expressed energy
- The ground system radiates longitudinal current waves
- Longitudinal waves run
 - Just under the earth's surface (surface waves)
 - Through the earth's subsurface (longitudinal waves)

What Did Tesla Say About The Earth

The terrestrial conductor is thrown into resonance with the oscillations impressed upon it just like a wire....

The planet behaves like a perfectly smooth or polished conductor of inappreciable resistance with capacity and self induction uniformly distributed along the axis of symmetry of wave propagation and transmitting slow electrical oscillations without sensible distortion and attenuation.³

³Nikola Tesla, Art of Transmitting Electrical Energy Through the Natural Medium, US Patent 787412, April 18, 1905.

Receiving Radiant Energy

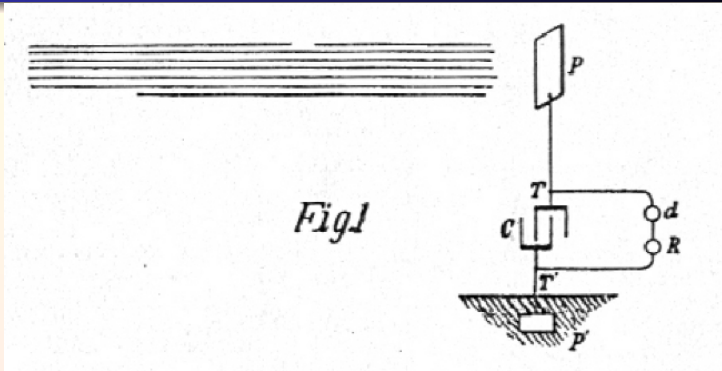

US Patent 685957, November 5, 1901

- C Capacitor
- d Circuit Controller
- P Insulated Plate Antenna
Highly polished or amalgamated: Receive uniformly
- P' Ground Plate; part of a ground tank circuit
- R Device to be Operated
- T, T' Terminals of the Capacitor

Apparatus For Transmitting Electrical Energy

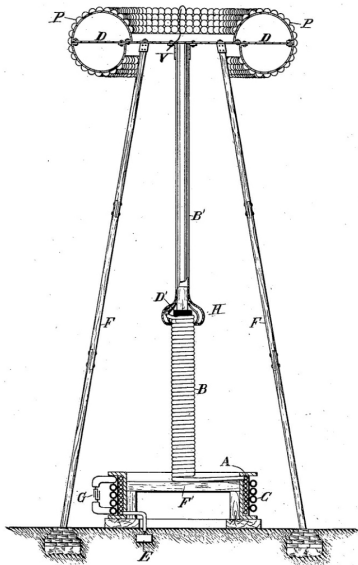

Tesla US Patent 1,119,732, December 1, 1914
Originally filed in 1902 with a renewal 1907

- A Secondary; Connected to Ground
- B Magnifier Coil
- B' Transmission line
- B B' Resonate at the same Wavelength
Propagation Velocities Different
and each is a 1/4 Wavelength
- C Primary; Isolated from Ground
- D Circular Plate cutting Toroid
in Half
- D' Dielectric Hood
- H Conducting Hood
- D'H Slides up and down to allow for tuning
- E Groundplate has volume and
Depth and capacitively coupled
to Earth
- F, F' Non-Conductive Supports
- G Capacitor: Pulsed energy tuned source
- P Small Hemispheres; Larger on top
- Toroid Acts as a Charge Reservoir

Tesla's Grounding System

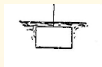

Tesla Ground Symbol



Circuit Ground Symbol



Chassis Ground Symbol

- The ground has to *grip* the earth
- The underground support of the tower is iron
- The depth of the central hole is 120 feet
- The central hole cross-section is 12 feet by 10 feet
- The conductive water table is at 80 feet
- At 120 feet there are four small diameter NSEW horizontal tunnels
- The horizontal tunnels extend 100 feet
- The ground is an element of a ground resonant coupler system
- The secondary ground is capacitively coupled to the earth
- Radiates Surface Waves and Longitudinal Subsurface Current Waves

Magnetometer: Underground Iron Supports For Tower

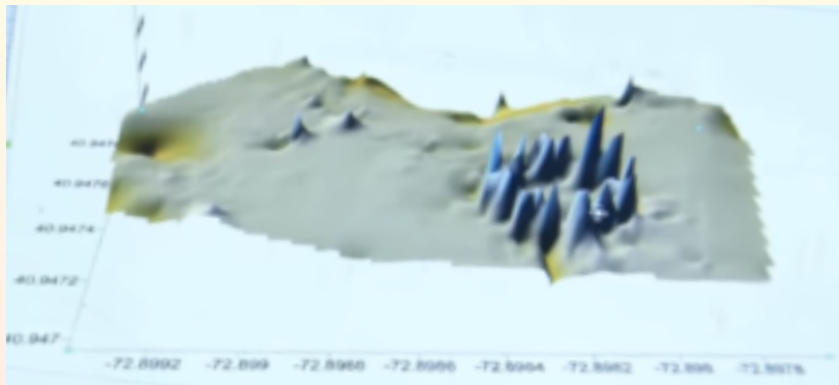

Exploring What Lies Beneath Nikola Tesla's Lab
<https://www.youtube.com/watch?v=PJEaGwShzhQ>
Published November 19, 2017

I could find no information confirming whether Tesla used these support iron pipes as part of his ground system. My intuition is yes.

Magnifying Transmitter Model



Notice the radiant ring layers around the Toroid

- Toroid Does Not Have Circular Cross-section
- Greater Hemisphere Area on Top than on Bottom
- Longitudinal Waves
- Light Radiation
- Electric Field Radiation
- Scalar Magnetic Field
- Antenna Glows
- No Dissipative Sparks

Illustration showing how the Tesla tower built at Wardenclyffe in 1901 would have looked completed.

Nikola Tesla, 'My Inventions V. The Magnifying Transmitter', *Electrical Experimenter*, June, 1919.

Dissipative Sparks: Leakage



Famous Double Exposure Photo

<http://cdn.history.com/sites/2/2017/06/GettyImages-526606232.jpg>

Magnifying Transmitter

“The Magnifying Transmitter

- is a resonant *Transformer*⁴ with a secondary
- in which the parts charged to a high potential
- are of considerable area
- and are arranged in space along ideal developing surfaces
- of very large radii of curvature
- and at proper distance from one another
- thereby insuring a small electric surface density everywhere
- so that no leak can occur
- even if the conductor is bare”

The Longitudinal Field is through Earth and Air

The Transverse Electric Field is negligible

Nikola Tesla, ' My Inventions V. The Magnifying Transmitter', *Electrical Experimenter*, June, 1919.

Nikola Tesla, 'The True Wireless', *Electrical Experimenter*, May, 1919

⁴Transformer is used in the generic sense

The Tesla Coil

- A tesla coil cannot be analyzed as a lumped element circuit
- A true Tesla coil is a velocity inhibited slow-wave helical transmission line resonator
- $V_{max} = SV_{min}$, where S is the standing wave ratio
- Voltage magnification is by a standing wave

Kenneth L. Corum and James F. Corum, *Class Notes: Tesla Coils and the Failure of Lumped-Element Circuit Theory*
http://www.teslaradio.com/pages/tesla_coils.htm

Longitudinal \vec{E} Field and Scalar S Magnetic Field

- Nikola Tesla
 - Concatenated Resonant Circuits
 - Biflar Pancake Coil
 - Short rise-time repetitive disruptive negative pulses
 - Spherical or Toroidal antenna
- Raymond Galinas
 - Uses a monopole antenna transmits from its end tip encased in a wave guide
 - Toroidal Coil to Transmit; Josephson Junction to Detect
- Bob Boyce
 - Generates such a short pulse that when the pulse reaches the antenna, the pulse at the transmitter is zero.
- Bob Zimmerman
 - Monopole Antenna to Transmit
 - Plasma Antenna to Receive
 - Longitudinal A-field
- Lee Hively
 - Bifilar Pancake Coil
 - Short Rise-Time Pulses

Understanding Tesla and Boyce

- Tesla: Generates repetitive disruptive short unipolar pulses
- Boyce: Generates such a short pulse that the pulse at the source is zero at the time when the pulse reaches the antenna
- The pulses must be negative going
- The leading edge of the pulse should have a large absolute time derivative
- The negative going pulse generates a densification of charge
- When the pulse returns to zero, it generates a rarefaction of charge
- The rarefaction of charge pulls the densification of charges of the following pulse
- The repeated pairs of densification of charge and rarefaction of charge constitute the Longitudinal Electric Wave

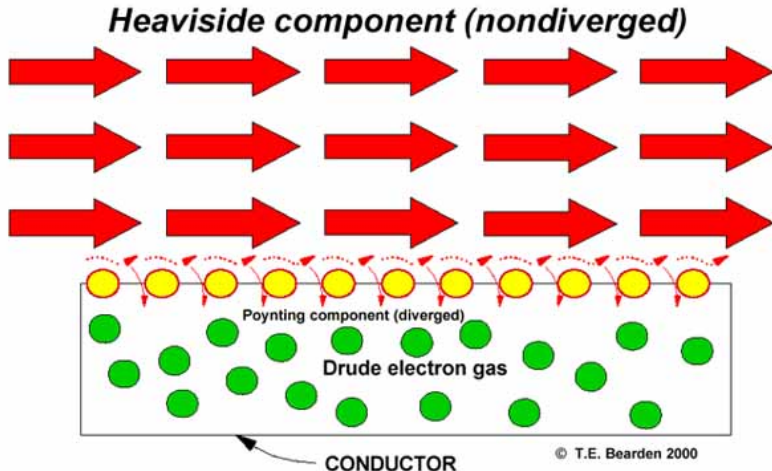

Figure 5. Heaviside and Poynting energy flow components. The Heaviside component is often 10 trillion times the Poynting component, but is simply wasted in ordinary single-pass energy flow circuits.

Heaviside and Poynting

- The Complete Energy Flow consists of
 - The Heaviside Current and the Poynting Current
- The Heaviside Current
 - Flows outside the wire
 - The Non-Diverged flow
 - Massless Displacement Current
- The Poynting Current flows
 - Just outside and Diverges into the wire
 - Conductive Current forms by Charged Mass movement inside the wire
 - Displacement Current goes through the capacitor dielectric

The Heaviside Signal

- 1 When the negative pulse at the source is initiated, it causes a traveling Longitudinal Electric Field surrounding the wire
- 2 The Longitudinal Electric wave has an accompanying Scalar Magnetic field
- 3 The Traveling Longitudinal Electric wave aligns the domains in the copper wire
- 4 Should there be a time when the pulse at the source and the pulse at the terminal end of the wire are simultaneously present
 - 1 The current starts to flow
 - 2 Generating a transverse \vec{B} field and \vec{E} field
- 5 Should there be a time when the pulse at the source is absent and the pulse at the end of the wire is present
 - 1 The longitudinal \vec{E} field and the magnetic scalar S field
 - 2 Radiate from the end of the wire

Heaviside Positive Feedback Network

The Tesla concatenated resonant system

- Constitutes a concatenated Heaviside feedback network
- Feedback is positive
- Making real part of the impedance negative
- Leading to an over-unity system

Wave Equations for Electric and Magnetic Vector Potentials

These are derivable directly from standard Maxwell's Equations

$$\frac{1}{c^2} \frac{\partial^2 \Phi}{\partial t^2} - \nabla^2 \Phi - \frac{\partial}{\partial t} \left(\vec{\nabla} \cdot \vec{A} + \frac{1}{c^2} \frac{\partial \Phi}{\partial t} \right) = \frac{\rho}{\epsilon}$$

$$\frac{1}{c^2} \frac{\partial^2 \vec{A}}{\partial t^2} - \vec{\nabla}^2 \vec{A} + \vec{\nabla} \left(\vec{\nabla} \cdot \vec{A} + \frac{1}{c^2} \frac{\partial \Phi}{\partial t} \right) = \mu \vec{J}$$

Recall that the scalar field S from the quaternion generalized Maxwell equations is given by

$$S = \vec{\nabla} \cdot \vec{A} + \frac{1}{c^2} \frac{\partial \Phi}{\partial t}$$

In gauge theory, $S = 0$ is the Lorenz gauge.

The Longitudinal Electric Wave And the Scalar Wave Fields

Recall that when $E_x = E_y = 0$, and $S \neq 0$, the general solution of the quaternion generalized Maxwell wave equation for the forward wave of E_z field is given by

$$E_z(z, t) = f(z - ct)$$

And from this it followed that the general solution for the forward scalar wave field S is given by

$$S(z, t) = \frac{f(z - ct)}{c}$$

The two can be called the Electro-Scalar wave field or the Electro-Scalar Field.

Magnetic Vector Potential Wave

Longitudinal Magnetic Vector Potential Field

We consider a charge and current free environment.

$$\vec{\nabla}^2 \vec{A} - \frac{1}{c^2} \frac{\partial^2 \vec{A}}{\partial t^2} = \vec{\nabla} \left(\vec{\nabla} \cdot \vec{A} + \frac{1}{c^2} \frac{\partial \Phi}{\partial t} \right)$$

$$\begin{aligned} \vec{\nabla}^2 \vec{A} - \frac{1}{c^2} \frac{\partial^2 \vec{A}}{\partial t^2} &= \vec{\nabla} S \\ &= \vec{\nabla} \frac{f(z - ct)}{c} \\ &= \frac{1}{c} \begin{pmatrix} 0 \\ 0 \\ f'(z - ct) \end{pmatrix} \end{aligned}$$

$$\frac{\partial^2 A_z}{\partial z^2} - \frac{1}{c^2} \frac{\partial^2 A_z}{\partial t^2} = \frac{f'(z - ct)}{c}$$

This is an in-homogeneous equation for the z-component of the magnetic vector potential.

Longitudinal Waves and Plasma Antennas

Longitudinal waves are possible if a curl-free magnetic vector potential field \vec{A} can be created:

$$\vec{\nabla} \times \vec{B} = \vec{\nabla} \times (\vec{\nabla} \times \vec{A}) = 0$$

A curl-free magnetic vector potential field can be generated by a

- long single layer solenoidal coil
- toroidal coil

driven by a current source

Raymond Galinas patented the idea in the 1980's

- US Patent 4429288
- US Patent 4447779
- US Patent 4429288
- US Patent 4491795
- US Patent 4605897

Apparatus and method for determination of a receiving device relative to a transmitting device utilizing a curl-free magnetic vector potential field

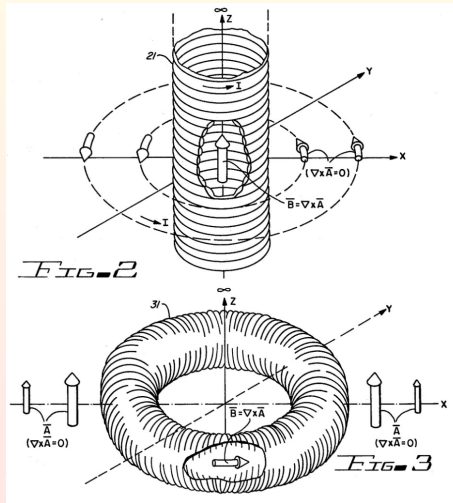

\vec{A} Created By A Long Solenoid

The \vec{A} field created by a long solenoidal coil, whose coil winding is connected to a current source $f(t)$, and whose cylindrical axis is in the Z -direction is given by

$$\vec{A}(x, y, z, t) = \text{const}_1 \cdot f(t) \begin{pmatrix} \frac{y}{x^2+y^2} \\ \frac{x}{x^2+y^2} \\ 0 \end{pmatrix}$$

The constants const_1 depend on the parameters of the geometry of the solenoid and number of turns of the coil

\vec{A} Created By a Toroidal Coil

The \vec{A} field created by a toroidal coil, whose cross-sectional area axis is on the horizontal plane, whose main axis is in the z-direction, and whose coil is connected to a current source $f(t)$ is given by

$$\vec{A}(x, y, z, t) = \text{const}_2 \cdot f(t) \begin{pmatrix} 0 \\ 0 \\ 1 \end{pmatrix}$$

The constant const_2 depends on the parameters of the geometry of the toroid and the number of turns of the coil

Galinas advocated using a Josephson Junction to detect the orientation of the magnetic vector potential

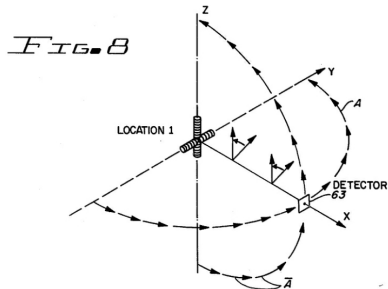
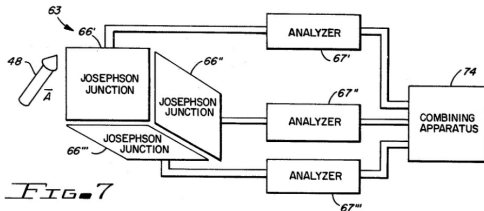

Apparatus and method for modulation of a curl-free magnetic vector potential field

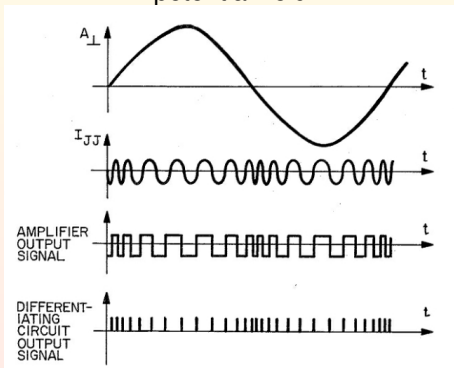

- A_{\perp} the A field perpendicular to the Josephson junction
- I_{JJ} the current that is generated by the Josephson junction

Apparatus and method for distance determination between a receiving device and a transmitting device utilizing a curl-free magnetic vector potential field

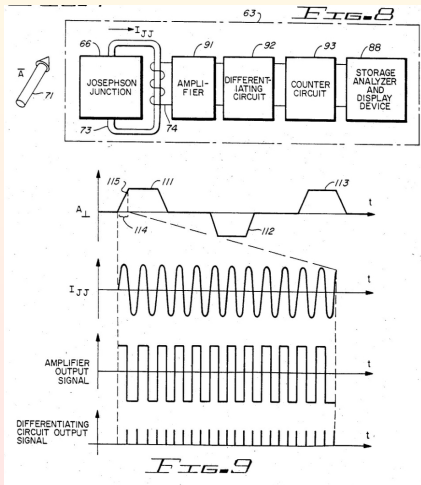

Robert Zimmerman

Plasmas Antennas For Longitudinal Waves

- Plasma Antenna can be as efficient as metal antennas
- Plasma Antenna can be switched off and on
- Plasma Antenna is driven by surface wave
- Surface waves have a transverse and longitudinal component
- With the right antenna geometry a plasma antenna
 - Can radiate the longitudinal component
 - Can detect the longitudinal component

Vertical Folded Dipole To Transmit A Longitudinal A field

Nikolova and Zimmerman, 2007

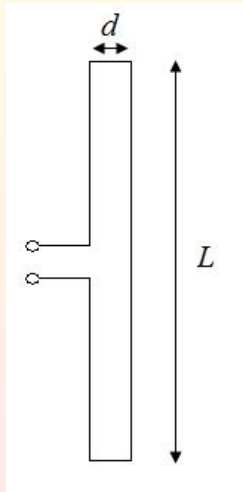

A vertically oriented folded dipole

Radiation Pattern of Vertical Folded Dipole

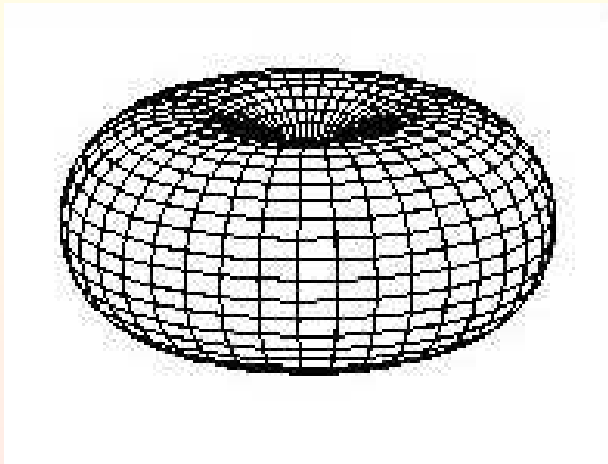

The electromagnetic field strength depiction of a vertically oriented folded dipole radiation. Notice that the field strength directly above and below the vertical axis of the folded dipole is at a minimum.

Half Wave Folded Radiation Pattern

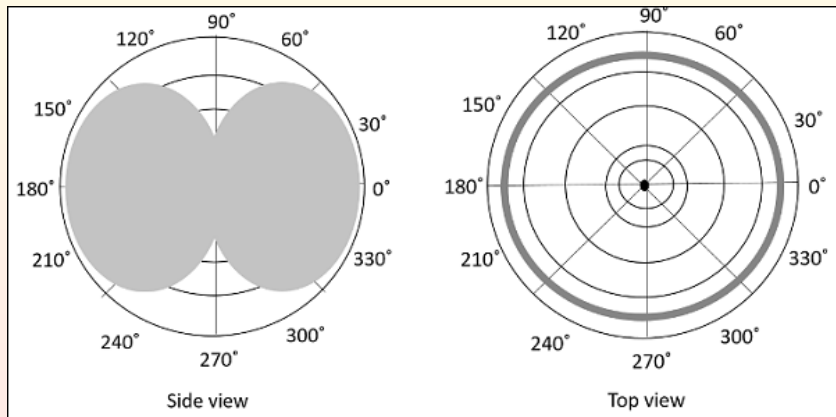

Side and top views of vertically oriented folded dipole radiation pattern

Horizontally Oriented Folded Dipole

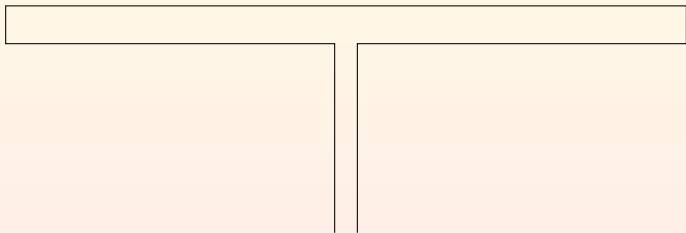

3D Radiation Pattern for Horizontal Folded Dipole

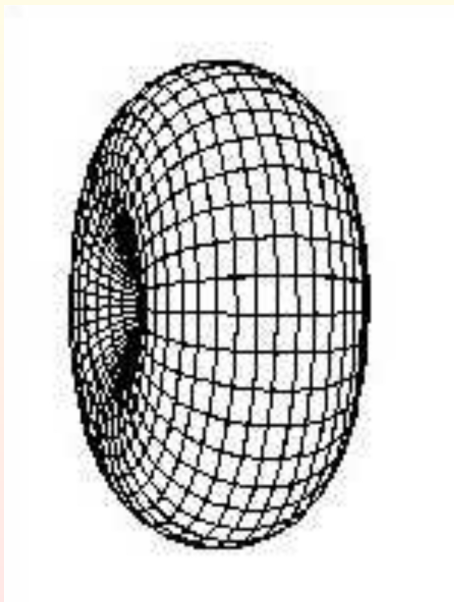

- 1 Natalia Nikolova and Robert Zimmerman, *Detection of the Time-dependent Electromagnetic Potential at 1.3 GHz*, Department of Electrical and Computer Engineering, McMaster University Report CEM-R-46, November 2007.
- 2 Robert Zimmerman, *Transmission and Reception of Longitudinally Polarized Momentum Waves*, QEX, July/August 2011, pp 31-35.
- 3 Robert Zimmerman, *Macroscopic Aharonov-Bohm Effect at L-Band Microwave Frequencies*, Modern Physics Letters B, Vol. 25, No. 9, 2011, pp. 649-662.
- 4 Natalia Nikolova and Robert Zimmerman, US Patent 8,165,531, April 24, 2012.
- 5 Robert Zimmerman, *Reception of Longitudinal Vector Potential Radiation With A Plasma Antenna*, Journal of Applied Physics, Volume 114, 2013, pp. 044907 1-6.

- Constructed a 1.3 GHz wireless link
- The folded dipole was placed in the horizontal plane
- The radiated magnetic vector field was oriented along the axis of the folded dipole
- The direction of propagation is in the direction of the axis of the folded dipole
- The magnetic vector potential component is longitudinally polarized with respect to the direction of propagation
- The radiated electric and magnetic fields were zero

Natalia Nikolova and Robert Zimmerman, *Detection of the Time-dependent Electromagnetic Potential at 1.3 GHz*, Department of Electrical and Computer Engineering, McMaster University Report CEM-R-46, November 2007.

Transmitting The Magnetic Vector Potential

- The electric intensity field \vec{E} is near zero at tip or short end of the folded dipole
- The magnetic flux density field \vec{B} is near zero at tip or short end of the folded dipole
- The \vec{E} field and \vec{B} field are zero and continue zero indefinitely in the direction of the axis of the folded dipole
- The longitudinal magnetic vector potential is radiated from the tip or short end of the folded dipole

Plasma Monopole Antenna Detector

- The magnetic vector potential can be detected and measured
- Using a biased low-temperature plasma antenna
- Formed from
 - U-shaped fluorescent light tube
 - Small neon tube
- The longitudinal potential wave is received along the axis of the monopole
- The receiver side RF signal is the result of the modulation of the local bias power

- Monopole antenna is 69cm long
- Wavelength of 1.3GHz is about 23 cm
- A 7 inch circular waveguide operating in the transverse magnetic TM_{01} mode
- Waveguide prevents the transmission of transverse waves
- Quarter Wavelength choke collar prevents currents on the inside from folding around the open end and radiating
- Longitudinal 1.3GHz magnetic vector potential carrier

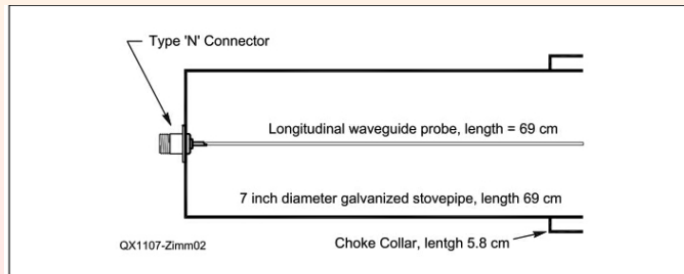

Fluorescent Tube Detector

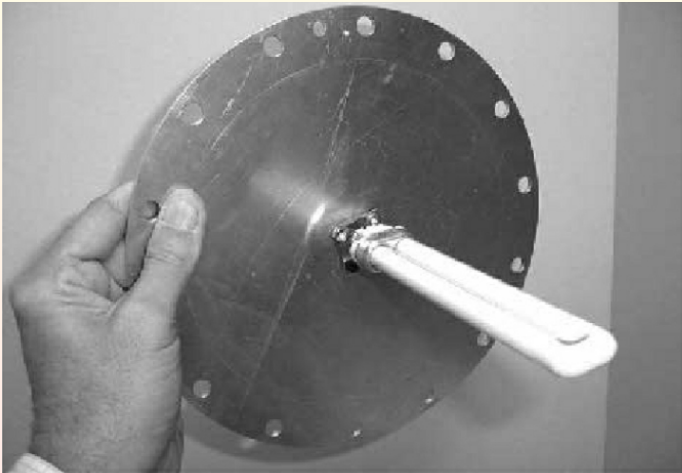

Robert Zimmerman, *Transmission and Reception of Longitudinally Polarized Momentum Waves*, QEX, July/August 2011.

Block Diagram Of Receiver

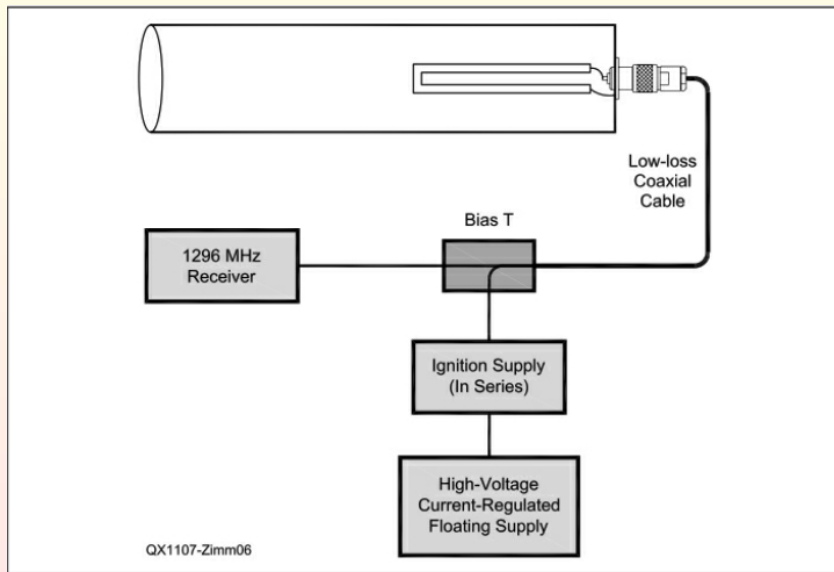

Bias T Schematic

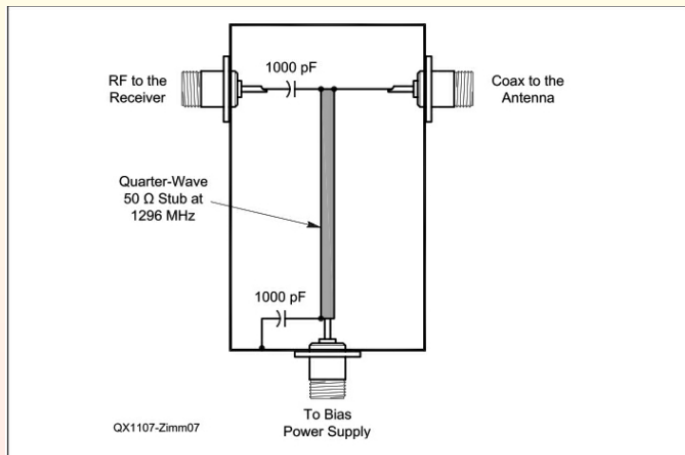

Robert Zimmerman, *Transmission and Reception of Longitudinally Polarized Momentum Waves*, QEX, July/August 2011.

Shows a schematic of the Bias T used to feed the bias current to the waveguide antenna

Conical Horn



Robert Zimmerman, *Transmission and Reception of Longitudinally Polarized Momentum Waves*, QEX, July/August 2011.

Shows the conical horn attached to the receiving waveguide

Schematic Of Fluorescent Plasma Antenna

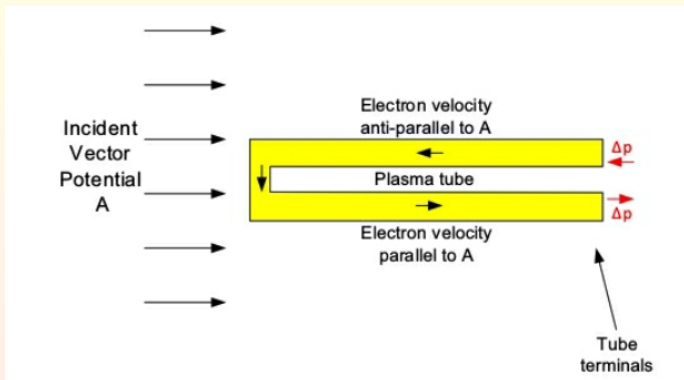

Zimmerman, Modern Physics Letters B, Vol 25, No. 9, 2011

The magnetic vector potential A approaches from the left. The electron flux in the upper leg of the tube is anti-parallel with magnetic vector potential and undergoes a decrease of momentum of Δp . The electron flux in the lower leg of the tube is parallel with magnetic vector potential and undergoes an increase of momentum of Δp .

The Transmitting Station



Robert Zimmerman, *Transmission and Reception of Longitudinally Polarized Momentum Waves*, QEX, July/August 2011.

Shows the transmitting station which is setup for the 1500 meter link.

Sherry Goeller is operating it.

The Receiving Station



Robert Zimmerman, *Transmission and Reception of Longitudinally Polarized Momentum Waves*, QEX, July/August 2011.

Shows the receiving station which is setup for the 1500 meter link.

Robert Zimmerman is operating it

Both Longitudinal Electric and Vector Potential Field

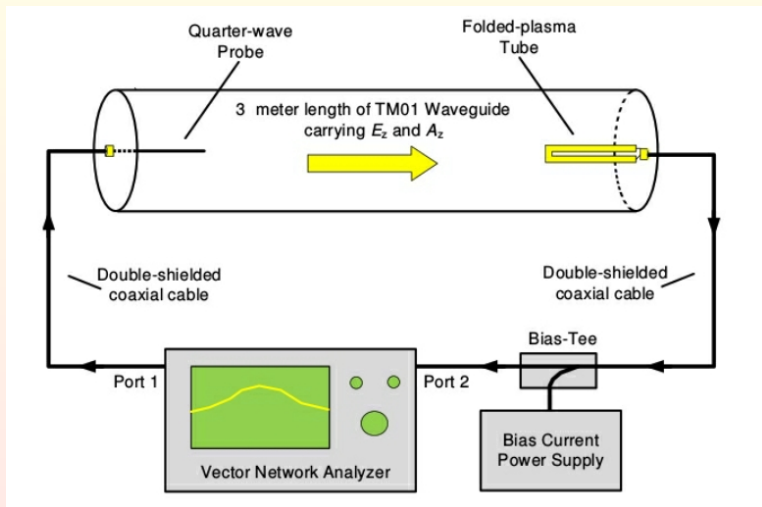

Robert Zimmerman, *Macroscopic Aharonov-Bohm Effect at L-Band Microwave Frequencies*, Modern Physics Letters B, Vol. 25, No. 9, 2011, pp. 649-662

Bias Current

- Bias Current is 200ma
- Power source is floating with DPDT switch to reverse polarity
- Coaxial center conductor connected to one leg of plasma antenna
- Shield of coaxial cable connected to grounded leg of plasma antenna
- Tube current is negative when coaxial center conductor is negative with respect to ground
- Reversing current results in a 180° phase shift of the detected A_z
- Reversing current results in no phase change of the detected E_z

Using Vector Network Analyzer To Compute E_z and A_z

- S_{21}^+ positive bias
- S_{21}^- negative bias
- A_z means the detected signal due to the Vector Magnetic Potential Field
- E_z means the detected signal due to the Electric Field

$$E_z = \frac{S_{21}^- + S_{21}^+}{2}$$

$$A_z = \frac{S_{21}^- - S_{21}^+}{2}$$

In-phase Out-of-Phase Differences

- E_z is the dominant signal
- For negative bias A_z and E_z are in phase and add
 - $-16dB \pm 1dB$
- For positive bias A_z and E_z are out of phase
 - $-21dB$
- $5dB$ decrease with positive bias

$$\Delta = 10 \log \left[\frac{E_z + A_z}{E_z - A_z} \right]^2 = 5dB$$

This implies

$$\left| \frac{A_z}{E_z} \right| = .5625$$

Technical Conclusions

- A folded plasma tube can receive E_z as a simple folded monopole antenna
- A folded plasma tube can detect A_z as a differential Aharonov-Bohm detector
- A_z and E_z can be calculated from amplitude/phase data collected with a vector network analyzer
- Detection of vector magnetic potential depends on having high velocity electron response to A_z
 - RF component of electron velocity due to A_z is $\approx 20m/s$ in the fluorescent tub plasma
 - RF component of electron velocity due to A_z is $\approx 3mm/s$ in copper
- In far field, E_z drops off as $1/R^2$
- In far field A_z drops off as $1/R$

Longitudinal Vector Magnetic Potential Waves

- Can be transmitted and detected
- Carry no power
- Detected signal power comes from the bias supply
- Without Transmitting Transverse Electromagnetic waves

Parabolic Antenna

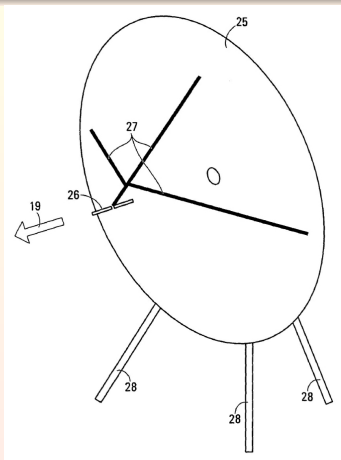

Nikolova and Zimmerman US Patent 8,165,531, April 24, 2012

Shows a highly directional dipole backed by a parabolic reflector. **25** is the parabolic reflector. **27** are the struts that support the dipole. **26** is the dipole. **28** are the leg supports. And **19** is the direction the potential wave is being transmitted. **19** is the direction of the transmitted longitudinal wave.

The Hedgehog Antenna

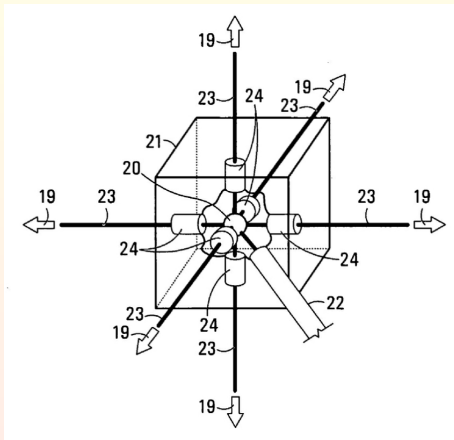

Nikolova and Zimmerman US Patent 8,165,531, April 24, 2012

Shows what they call a hedgehog antenna. **21** is the enclosing box. The size and shape of the enclosing box is selected to provide the desired impedance. **23** is the radiating wires. They are a quarter wavelength. **19** is the direction of the transmitted longitudinal wave.

Two Neon Tubes For Plasma Antenna

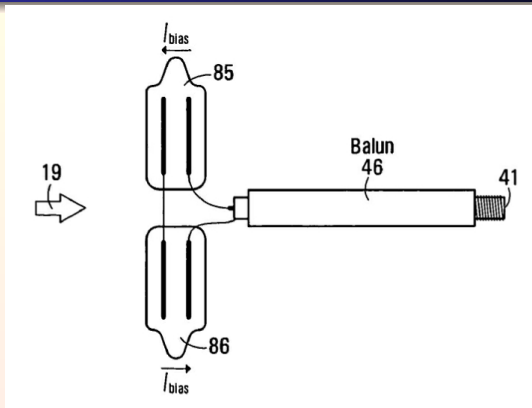

Nikolova and Zimmerman US Patent 8,165,531, April 24, 2012

Shows a plasma antenna constructed of two neon tubes connected in series. **85** and **86** are the two neon tubes. **46** is the balun and **41** is the coaxial cable. **19** is the incoming direction of the longitudinal magnetic vector potential wave. Notice that in the top neon tube, the current direction and the magnetic vector potential are opposite. In the bottom neon tube, they are parallel.

Neon Bulb Plasma Antenna Setup

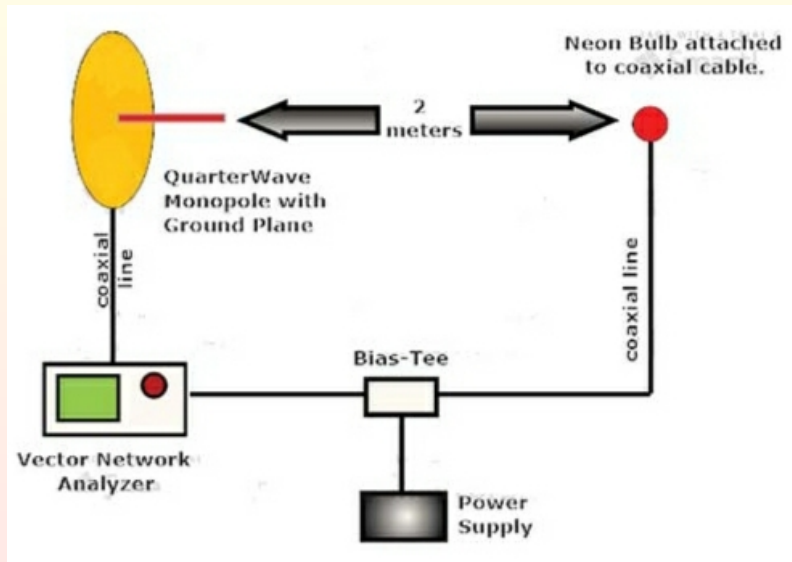

Robert Zimmerman, *Reception of Longitudinal Vector Potential Radiation With A Plasma Antenna*, Journal of Applied Physics, Volume 114, 2013, pp. 044907 1-6.

Transmitting Monopole With Ground Plane

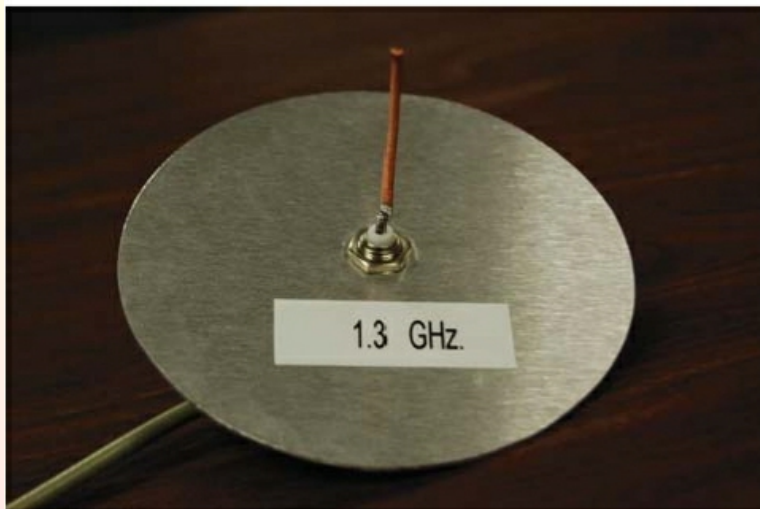

Robert Zimmerman, *Reception of Longitudinal Vector Potential Radiation With A Plasma Antenna*, Journal of Applied Physics, Volume 114, 2013, pp. 044907 1-6.

Quarter Wave, Length $\approx 5.76\text{cm}$, Radius of Ground Plane

Receiving Neon Bulb Plasma Antenna

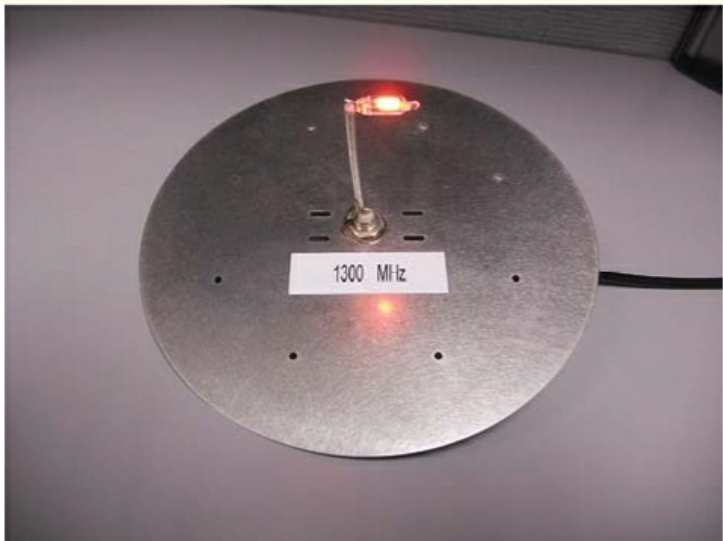

Robert Zimmerman, *Reception of Longitudinal Vector Potential Radiation With A Plasma Antenna*, Journal of Applied Physics, Volume 114, 2013, pp. 044907 1-6.

8.8ma Bias Current

Replication of Zimmerman's Experiments

- Antenna Test Range for 1296.1 MHz
- Folded Dipole Antenna
- Monopole Antenna
- Waveguide Transmit Antenna
- Plasma Tube in a Waveguide Antenna
- Plasma Tube in a Quartz Glass Jar
- Copper Tube in a Quartz Glass Jar

George Works and Shelley Works, *Confirmation Measurements of Vector Potential waves*, QEX July/August 2012, pp. 3-7.

Antennas



George Works with the different antennas

The Waveguides

- 178mm diameter
- 690mm long
- Transmit waveguide is made from brass sheets
- Receive waveguide is made of copper screen wrapped in fiberglass epoxy
- Waveguide chokes

Monopole Antenna

- Quarter wave probe
- Mounted N connector
- Centered on brass plate, diameter quarter wave
- Plasma tube in bottle 4db less sensitive

Plasma Bias Current

- DC-converter delivers 260V to un-ionized lamp
- Drops to 65V after lamp ionizes
- Ionizing supply
 -
 - Cold Cathode fluorescent lamp inverter
 - With Voltage Doubler rectifier circuit
 - Ionizing the lamp requires 1600V DC
 - Momentary switch activates the ionizing supply
- Bias polarity switch to provide plasma tube with either positive or negative bias current
- Replicated the 5dB difference between the negative bias and the positive bias

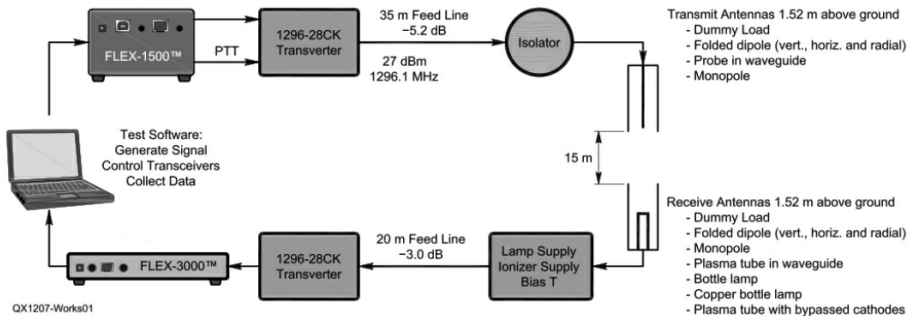

The equipment setup

- Flex-1500 transceiver in USB mode to transmit
- Flex-3000 transceiver, receive bandwidth 500Hz
- 26.1 Dbm (400mw) power at the transmit antenna

Modeling Antenna

* Total Field

EZNEC Pro/2

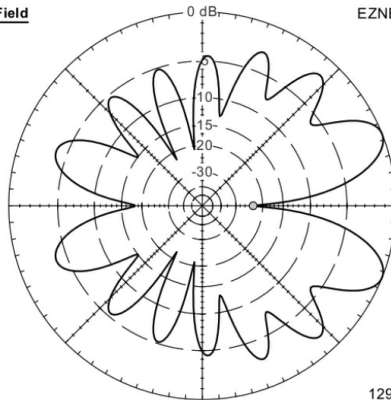

1296.1 MHz

Azimuth Plot
Observation Ht 1524 mm
Outer Ring 8.59 dBi

Cursor Az 0.0 deg.
Gain -14.34 dBi
-22.93 dBmax

Slice Max Gain 8.59 dBi @ Az Angle = 22.0 deg.
Front/Back 3.78 dB
Beamwidth 19.6 deg.; -3dB @ 11.6, 31.2 deg.
Sidelobe Gain 8.59 dBi @ Az Angle = 338.0 deg.
Front/Sidelobe 0.0 dB

EZNEC Pro/2 Computed Azimuth Pattern

Conclusions

- If there were an antenna that had deep nulls in
 - Horizontal
 - Vertical
 - Radial
- fields at the same azimuth angle, then
- any signal detected in that null with a plasma receiving antenna would be due to a vector potential wave.

Then despite their own measurements and computed patterns, they say:

We have not discovered such an antenna, either through modeling or measurements.

ElectroScalar Waves

Hively's 8 GHz Monopole Antenna

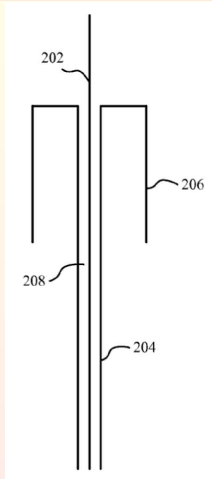

Hively US Patent 9306527, April 5, 2016

202 is a linear first conductor; it may extend from a coaxial cable. **204** is a tubular second conductor; it may extend from the outer conductor of a coaxial cable. **206** is an annular skirt balun. **208** is a tubular dielectric coaxially disposed between the first conductor and the second conductor.

Hively's Annular Skirt Balun

- May extend out to one fourth of a the wavelength of the operating frequency
- It is configured to cancel the return current on the outer surface of the second conductor.
- The balun should attenuate about 67db to make the antenna radiate like a monopole

Faraday Cage

- The Faraday cage is designed to block the impinging transverse electromagnetic waves
- Cylindrical copper pipe with both ends of the copper pipe soldered to hemispherical copper end caps
- Antenna is enclosed in the copper pipe
- The outer conductor of the coaxial cable is soldered to one end cap

Attenuation Versus log Distance

The antennas are aligned.

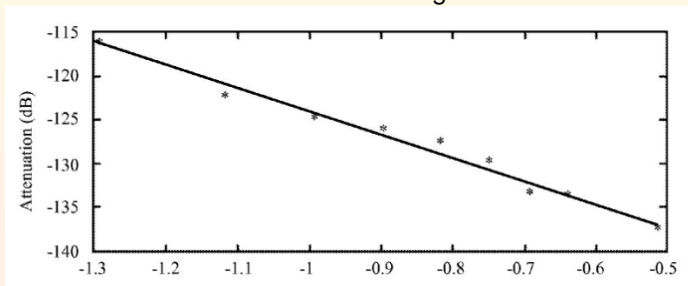

Hively US Patent 9306527

Shows a plot of the attenuation versus \log_{10} distance in meters. -1.3 corresponds to .05 meters (5cm) and -0.522 corresponds to .3 meters (30cm).

Bifilar Pancake Coil

- Transmitter generates repeated short rise time pulses
- Linked to antenna by bifilar pancake coil
- The outer conductor connects to the inner conductor
- Every loop of wire wound clockwise is adjacent to a loop of wire wound counter-clockwise at the center.
- The magnetic field created by adjacent turns of the pancake coil cancel

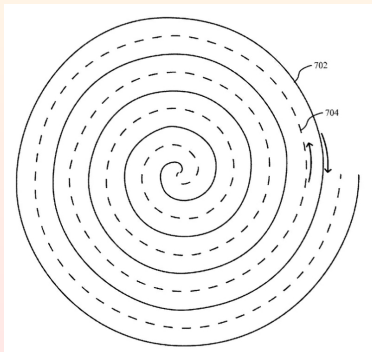

Tesla Quote

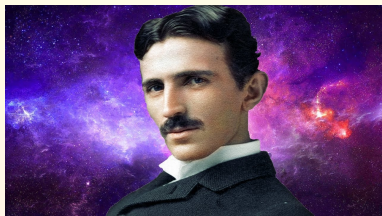

Today's scientists have substituted mathematics for experiments, and they wander off through equation after equation, and eventually build a structure which has no relation to reality.



Eric Dollard agrees.

Slides can be found on my website haralick.org
http://haralick.org/conferences/maxwell_slides_ESTC.pdf

Thankyou for listening

Questions ?

